



FARGO®
DTC1250E, DTC1000ME, DTC4250E,
AND DTCII CARD PRINTER
USER GUIDE

PLT-01668

Version: 1.2

December 2016

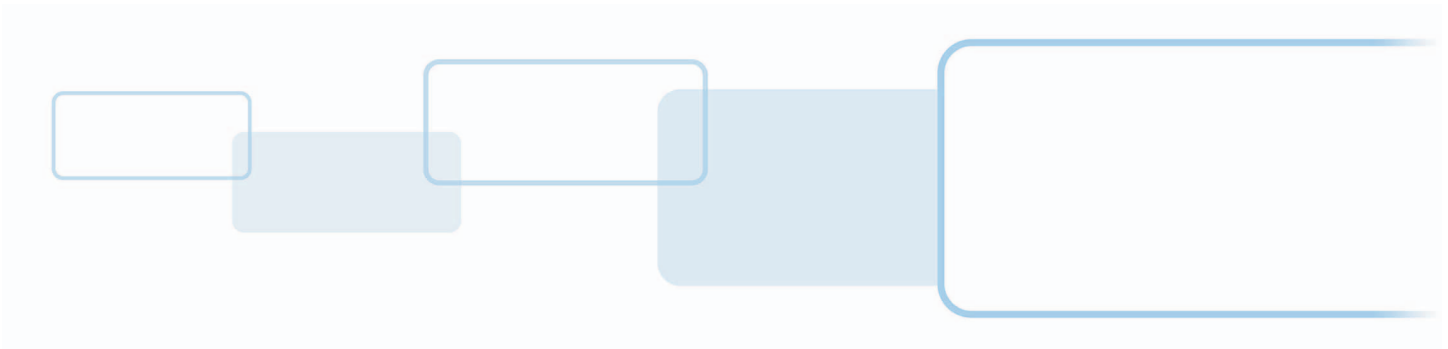

Copyright

© 2014 - 2016 HID Global Corporation/ASSA ABLOY AB. All rights reserved.

This document may not be reproduced, disseminated or republished in any form without the prior written permission of HID Global Corporation.

Trademarks

HID GLOBAL, HID, the HID logo, and FARGO are the trademarks or registered trademarks of HID Global Corporation, or its licensors, in the U.S. and other countries. All other trademarks, service marks, and product or service names are trademarks or registered trademarks of their respective owners.

MIFARE and MIFARE DESFire are registered trademarks of NXP B.V. and are used under license.

Contacts

For additional offices around the world, see www.hidglobal.com corporate offices.

Americas and Corporate

611 Center Ridge Drive
Austin, TX 78753
USA
Phone: 866 607 7339
Fax: 949 732 2120

Asia Pacific

19/F 625 King's Road
North Point, Island East
Hong Kong
Phone: 852 3160 9833
Fax: 852 3160 4809

Europe, Middle East and Africa (EMEA)

Haverhill Business Park Phoenix Road
Haverhill, Suffolk CB9 7AE
England
Phone: 44 (0) 1440 711 822
Fax: 44 (0) 1440 714 840

Brazil

Condomínio Business Center
Av. Ermano Marchetti, 1435
Galpão A2 - CEP 05038-001
Lapa - São Paulo / SP
Brazil
Phone: +55 11 5514-7100

HID Global Customer Support: www.hidglobal.com/customer-service



Contents

- Chapter 1: Specifications 1-1**
 - 1.1 Regulatory Compliance 1-1
 - 1.1.1 Agency Listings 1-1
 - 1.1.2 United States 1-2
 - 1.1.3 Canada 1-2
 - 1.1.4 Taiwan 1-2
 - 1.1.5 Japan 1-2
 - 1.1.6 Korea 1-2
 - 1.2 Safety Messages 1-3
 - 1.2.1 Safety Messages - United States 1-3
 - 1.2.2 Safety Messages - French 1-4
 - 1.2.3 Safety Messages - Taiwan 1-5
 - 1.2.4 Safety Messages - China 1-6
 - 1.3 Technical Specifications 1-7
 - 1.4 Functional Specifications 1-9
 - 1.5 Printer Components: Print Ribbons 1-9
 - 1.5.1 Ribbon Types and Print Counts 1-10
 - 1.6 Printer Components: Blank Cards 1-11
- Chapter 2: Setup and Installation Procedures 2-1**
 - 2.1 Choosing a Good Location 2-1
 - 2.1.1 About Moisture Condensation 2-1
 - 2.2 Unpacking and Inspection 2-2
 - 2.3 Installing the Print Ribbon Cartridge 2-2
 - 2.3.1 Installing the Ribbon 2-2
 - 2.4 Installing Blank Cards into the Input Card Hopper 2-3
 - 2.5 Card Size Selection 2-5
 - 2.6 Connecting the Printer Power 2-7
- Chapter 3: Print Driver Installation 3-1**
 - 3.1 Print Driver Installation 3-1
 - 3.2 Driver Installation Instructions 3-2
- Chapter 4: Printer Preferences 4-1**
 - 4.1 Card Tab 4-1
 - 4.1.1 Toolbox Window 4-3

4.1.1.1	Configuration Tab	4-3
4.1.1.2	Calibrate Ribbon Tab	4-4
4.1.1.3	Clean Printer Tab	4-5
4.1.1.4	Safety Messages (Review Carefully)	4-6
4.1.1.5	Advanced Settings Tab	4-13
4.2	Device Options Tab	4-17
4.2.1	Fluorescent Panels	4-19
4.2.1.1	Selecting the Fluorescent Panel Ribbon Type (DTC4250e only)	4-19
4.2.1.2	Creating a Custom Fluorescent Image using the YMCFKO Ribbon	4-20
4.3	Configuring Fluorescent Data using the Application	4-20
4.4	Image Color Tab	4-22
4.4.1	Advanced Settings	4-24
4.5	Image Calibrate	4-25
4.6	Magnetic Encoding Tab	4-26
4.6.1	Magnetic Track Options	4-29
4.6.1.1	Reviewing the Sample String	4-29
4.6.1.2	Sending the Track Data	4-29
4.7	Overlay / Print Area	4-31
4.7.1	Defining an Overlay or Print Area	4-31
4.8	K Panel Resin Tab	4-35
4.8.1	Defined Area	4-36
4.8.1.1	Method for Defining a Single Area	4-36
4.8.1.2	Method for Defining Multiple Areas	4-36
4.9	Printer Info	4-37
Chapter 5:	System Overview - Troubleshooting	5-1
5.1	Sequence of Operations	5-1
5.2	Troubleshooting	5-2
5.2.1	Printer Error Buttons	5-2
5.2.2	Error Messages	5-4
5.2.3	Troubleshooting with the Error Message Table	5-5
5.2.4	Printer-Specific Tools (DTC1250E, DTC4250E)	5-10
5.2.4.1	Additional Printer Specific Tools	5-11
Chapter 6:	Firmware Upgrades	6-1
6.1	Upgrade Information	6-1
Chapter 7:	Technical Support	7-1
7.1	Reading the Serial Numbers on a FARGO Printer	7-1
Appendix A:	DTCii	A-1
A.1	Locking System	A-1
A.2	Accessory Procedures: Using the Security Lock Slot	A-1

Chapter 1

Specifications

The purpose of this section is to provide you with specific information on the Regulatory Compliances, Agency Listings, Technical Specifications and Functional Specifications for the DTC1250e, DTC1000Me, DTC4250e, and DTCii Card Printers.

1.1 Regulatory Compliance

UL	The Card Printer is listed under UL 60950-1 (2 nd edition) Information Technology Equipment File Number: E145118 Note: This product is intended to be supplied by a Listed Power Unit marked Class 2 and rated for 24Vdc, 3.3A minimum.
CSA	The Printer manufacturer has been authorized by UL to represent the Card Printer as CSA Certified under CSA Standard C22.2 No. 60950-1-07 2 nd edition File Number: E145118
FCC	The Card Printer complies with the requirements in Part 15 of the FCC rules for a Class A digital device.
CE	The Card Printer has been tested and complies with EN300-330-1, EN300-330-2, EN301-489-1, EN301-489-3, EN55022 class A, EN55024, EN6100-3-2, EN6100-3-3, EN60950-1. Note: Based on the above testing, the Printer manufacturer certifies that the Card Printer complies with the following European Council Directives and has placed the CE mark on the Card Printer. LVD 2006/95/EC, EMC 2004/108/EC, R&TTE 1999/5/EC, ROHS2 2011/65/EC
Environmental	ENERGY STAR, RoHS2, China RoHS, Power supply Efficiency level V minimum

1.1.1 Agency Listings

Emissions and Immunity Standards	FCC Part 15 Class A, RSS-GEN, RSS 210, CNS 13438, EN55022 Class A, EN55024, EN6100-3-2, EN6100-3-3, EN300-330-1, EN300-330-2, EN301-489-1, EN301-489-3, GB9254, GB17625
Safety Standards	UL IEC 60950-1 (2 nd edition), CSA C22.2 No. 60950-1-07(2 nd edition), EN60950-1, GB4943, CNS14336
Additional Agency Listings	CCC, BSMI, KC

1.1.2 United States

This device complies with Part 15 of the FCC rules. Operation is subject to the following two conditions:

1. This device may not cause harmful interference.
2. This device must accept any interference received, including interference that may cause undesired operation.

Note: This equipment has been tested and found to comply with the limits for a Class A digital device, pursuant to part 15 of the FCC Rules. These limits are designed to provide reasonable protection against harmful interference when the equipment is operated in a commercial environment. This equipment generates, uses, and can radiate radio frequency energy and, if not installed and used in accordance with the instruction manual, may cause harmful interference to radio communications. Operation of this equipment in a residential area is likely to cause harmful interference; in which case, you are required to correct the interference at your expense.

IMPORTANT: Changes or modifications to an intentional or unintentional radiator not expressly approved by the party responsible for compliance could void the user's authority to operate the equipment.

1.1.3 Canada

This device complies with Industry Canada license-exempt RSS standard(s). Operation is subject to the following two conditions: (1) this device may not cause interference, and (2) this device must accept any interference, including interference that may cause undesired operation of the device.

Le présent appareil est conforme aux CNR d'Industrie Canada applicables aux appareils radio exempts de licence. L'exploitation est autorisée aux deux conditions suivantes: (1) l'appareil ne doit pas produire de brouillage, et (2) l'utilisateur de l'appareil doit accepter tout brouillage radioélectrique subi, même si le brouillage est susceptible d'en compromettre le fonctionnement.

1.1.4 Taiwan

經型式認證合格之低功率射頻電機，非經許可，公司、商號或使用者均不得擅自變更頻率、加大功率或變更原設計之特性及功能。低功率射頻電機之使用不得影響飛航安全及干擾合法通信；經發現有干擾現象時，應立即停用，並改善至無干擾時方得繼續使用。前項合法通信，指依電信法規定作業之無線電通信。低功率射頻電機須忍受合法通信或工業、科學及醫療用電波輻射性電機設備之干擾。

1.1.5 Japan

この装置は総務省の型式指定を受けています。”

(総務省指定番号は第 AC-14019 号です)

本製品は電波を使用した RFID 機器の読み取り□書き込み装置です。





そのため使用する用途□場所によっては、医療機器に影響を与える恐れがあります

1.1.6 Korea





이 기기는 업무용 (A 급) 전자파 적합기기로서 판매자 또는 사용자는 이 점을 주의하시길 바라며, 가정 외의 지역에서 사용하는 것을 목적으로 합니다.

1.2 Safety Messages

1.2.1 Safety Messages - United States



Symbol	Critical Instructions for Safety Purposes
<p>Danger:</p> 	<p>Failure to follow these guidelines results in personal injury or death.</p> <p>To prevent personal injury or death:</p> <ul style="list-style-type: none"> • Reference the following safety messages before performing an operation. • Always remove the power cord prior to performing repair procedures, unless otherwise specified. • Ensure only qualified personnel perform these procedures.
<p>ESD:</p> 	<p>This device is electro statically sensitive. You may damage the device if exposing it to static electricity discharges.</p> <p>To prevent damage:</p> <ul style="list-style-type: none"> • Reference the following safety messages before performing an operation. • Observe all established Electrostatic Discharge (ESD) procedures while handling cables in or near the Circuit Board and Printhead Assemblies. • Always wear an appropriate personal grounding device. • Always remove the Ribbon and Cards from the Printer before making any repairs, unless otherwise specified. • Remove jewelry and thoroughly clean hands before working on the Printer.
<p>Caution:</p> 	<p>This symbol warns of an electrical hazard that could result in personal injury or death.</p>
<p>Caution:</p> 	<p>For safety purposes, do not use Ethernet for a direct connection outside of the building.</p>

1.2.2 Safety Messages - French

Symbole	Instructions critiques visant la Sécurité
<p>Danger:</p> 	<p>Si ces directives ne sont pas suivies les résultats peuvent être des lésions corporelles ou la mort.</p> <p>Pour éviter des lésions corporelles ou la mort:</p> <ul style="list-style-type: none"> • Rapportez-vous aux avis suivants de sécurité avant de procéder à une opération. • Retirez toujours le câble d'alimentation avant d'effectuer des procédures de réparation, sauf spécification contraire. • Assurez-vous qu'uniquement des personnes qualifiées réalisent des procédures.
<p>ESD:</p> 	<p>Ce dispositif est sensible à l'électricité statique. Il peut souffrir des dommages s'il est exposé à des décharges électrostatiques.</p> <p>Pour éviter des dommages:</p> <ul style="list-style-type: none"> • Rapportez-vous aux messages suivants avant de procéder à une opération. • Suivez toutes les procédures de Décharges Electrostatiques (ESD) en vigueur durant le maniement des câbles dans ou à proximité des Ensembles de Cartes de Circuit Imprimé et Tête d'Impression. • Portez toujours un dispositif de mise à la terre personnelle appropriée. • Retirez toujours le ruban et les Cartes de l'Imprimante avant d'effectuer toute réparation, sauf spécification contraire. • Retirez tous bijoux et lavez soigneusement vos mains avant de travailler à l'Imprimante.
<p>Attention:</p> 	<p>Ce symbole est un avis de péril électrique passible de résulter en lésion corporelle ou mort.</p>
<p>Attention:</p> 	<p>Pour des motifs de sécurité, n'utilisez pas Ethernet pour une connexion directe hors du bâtiment.</p>





1.2.3 Safety Messages - Taiwan

繁體中文 射頻發射及安全指令 安全訊息（小心檢查）

標記	重要的安全事項說明
危險: 	<p>未按照說明安裝可能造成人員傷亡。 在可能產生潛在安全問題的地方有警示標記。 （如左圖所示）。</p> <ul style="list-style-type: none"> 為了避免人員傷害，在進行有此警示標記的操作前，請先參考安全資訊提示。 為了避免人員傷害，在沒有特別說明的情況下，修理前請關掉電源開關。
小心: 	<p>此設備對靜電很敏感。如果受到靜電放電，設備會損壞。 在可能產生潛在靜電安全問題的地方有警示標記。 （如左圖所示）。</p> <ul style="list-style-type: none"> 為了避免損壞設備，在進行有此警示標記的操作前，請先參考安全資訊提示。 為了避免損壞設備，在排放電路板和印刷頭聯合裝置裡面或附近的電線時，請注意觀察所有的靜電放電設備。 為了避免損壞設備，請隨時佩戴合適的接地裝置（比如：手腕上戴一個高品質的接地手腕帶以免受到可能的傷害）。 為了避免損壞設備，如果沒有特殊說明，在做任何修理前，請取下印表機上的色帶和卡。 為了避免損壞設備，在使用印表機之前，請摘下戒指和手上飾品，並仔細清洗手上的油脂。

1.2.4 Safety Messages - China

安全消息（请仔细阅读）

符号	涉及安全的重要过程
危险： 	如果不遵循这些安装指南进行操作，可能会导致重伤，甚至死亡。 可能引发安全问题的信息由警告符号（如左图所示）来表示。 <ul style="list-style-type: none"> 为了确保人身安全，在执行前面带有此符号的操作之前，请先阅读下面的安全消息。 为了确保人身安全，除非另有规定，否则在执行维修过程前，始终应断开电源。
小心： 	此设备为静电敏感设备。如果暴露在静电电流下，可能会损坏设备。 可能引发静电安全问题的信息由警告符号（如左图所示）来表示。 <ul style="list-style-type: none"> 为了防止设备或介质受损，在执行前面带有此符号的操作之前，请先阅读下面的安全消息。 为了防止设备或介质受损，请在处理电路板和打印头部件中或附近的电缆时，遵守所有规定的静电放电（ESD）过程。 为了防止设备或介质受损，请始终佩带适当的个人接地设备（例如，已接地避免出现潜在损坏的高质量腕带）。 为了防止设备或介质受损，除非另有规定，否则在执行任何维修过程前，始终应将色带和证卡与打印机分离。 为了防止设备或介质受损，在操作打印机前，请取下手指和手上的珠宝首饰物，并将手上的油渍和污渍彻底清洗干净。
	仅适用于海拔 2000m 以下地区安全使用 Use only at altitudes not more than 2000m above sea level.
	仅适用于非热带气候条件下安全使用
	环境保护（中国 -RoHS） 环保使用期是基于本产品用于办公环境。 Environmental Protection Use Period is based on the product being used in an office environment.

1.3 Technical Specifications

Term	Function
Print Method	Dye Sublimation / Resin Thermal Transfer
Print resolution	300 dpi (11.8 dots/mm); continuous tone
Colors	Up to 16.7 million colors / 256 shades per pixel
Print Ribbon Options	<p>Full-color with resin black and overlay panel, YMCKO* (500 prints)</p> <p>Full-color half-panel with resin black and overlay panel, YMCKO* (850 prints)</p> <p>Full-color with two resin black panels and overlay panel, YMCKOK* (500 prints)</p> <p>Full-color with fluorescing, resin black panel and overlay panel, YMCFO* (500 prints)</p> <p>Full-color with fluorescing, two resin black panels and overlay panel, YMCFOK* (400 prints)</p> <p>Full-color half-panel with two resin black and overlay panel, YMCKOK* (500 prints)</p> <p>Full-color half-panel with two resin black and two overlay panels, YMCKOK* (500 prints)</p> <p>Resin black and overlay panel, KO* (1250 prints)</p> <p>Dye-sublimation black and overlay print, BO* (1250 prints)</p> <p>Resin black (standard and premium) (3000 prints)</p> <p>Resin green, blue, red, white (1000 prints)</p> <p>Resin silver (2000 prints)</p> <p>Resin gold (1000 prints)</p> <p>Rewrite technology - No ribbon is required</p> <p>* Indicates the ribbon type and the number of ribbon panels printed where Y=Yellow, M=Magenta, C=Cyan, K=Resin Black, O=Overlay, F=Fluorescing Resin</p>
Print Speed	<p>6 seconds per card (K*)</p> <p>8 seconds per card (KO*)</p> <p>16 seconds per card (YMCKO*)</p> <p>24 seconds per card (YMCKOK*)</p> <p>Print speed indicates an approximate batch print speed and is measured from the time a card feeds into the printer to the time it ejects from the printer. Print speeds do not include encoding time or the time needed for the PC to process the image.</p> <p>Process time is dependent on the size of the file, the CPU, amount of RAM and the amount of available resources at the time of the print.</p> <p>* Indicates the ribbon type and the number of ribbon panels printed where Y=Yellow, M=Magenta, C=Cyan, K=Resin Black, O=Overlay, F=Fluorescing Resin</p>
Card Size and Types Supported	<p>CR-80 (3.375"L x 2.125"W / 85.6mmL x 54mmW)</p> <p>CR-79 (3.313"L x 2.063"W / 84.1mmL x 52.4mmW)</p>
Accepted Standard Card Sizes	<p>CR-80 edge-to-edge (3.36"L x 2.11"W/85.3mmL x 53.7mmW)</p> <p>CR-79 (3.3"L x 2.04"W/83.8mmL x 51.8mmW)</p>
Accepted Card Thickness	.009" - .040" / 9 mil - 40 mil/.229mm - 1.016mm

Term	Function
Accepted Card Types	PVC or polyester cards with polished PVC finish; monochrome resin required for 100% polyester cards; optical memory cards with PVC finish; rewrite.
Input Hopper Card Capacity	100 cards (.030"/.762mm) DTC1250e, DTC1000Me, DTC4250e 200 cards (.030"/.762 mm) DTC4250E (Dual Hopper)
Output Hopper Card Capacity	100 cards (.030"/.762mm) DTC4250e 30 cards (.030"/.762mm) DTC1250e
Reject Hopper Card Capacity	100 cards (.030"/.762mm) - same-side input/output card hopper (required)
Card Cleaning	Card cleaning roller integrated into the ribbon cartridge. A new cleaning roller is included with each ribbon cartridge.
Printer Memory	32MB RAM
Operating Systems	Windows® XP/Vista® (32 bit & 64 bit)/Server 2003 & 2008/Windows 7 (32 & 64 bit)/Windows 8 (32 & 64 bit)/Linux®
Interface	USB 2.0 and Ethernet with internal print server
Operating Temperature	65° F to 80° F / 18° C to 27°C
Humidity	20-80% non-condensing
Dimensions	<p>The dimensions for the DTC1250e: Single-Sided Printer: 8.8"H x 13.7"W x 7.9"D/224mmH x 348mmW x 201mmD (DTC1000Me) Dual-Sided Printer: 9.8"H x 18.7"W x 9.2"D/249mmH x 475mmW x 234mmD</p> <p>The dimensions for the DTC4250e: Single-Sided Printer: 9.8"H x 18.1"W x 9.2"D/249mmH x 460mmW x 234mmD Dual-Sided Printer: 9.8"H x 18.7"W x 9.2"D/249mmH x 475mmW x 234mmD</p>
Weight	Single-Sided: 8 lbs./3.63 Kg; Dual-Sided: 10 lbs./4.54 Kg
Agency Listings	Safety: UL 60950-1, CSA C22.2 (60950-1), and CE; EMC; FCC Class A, CRC c1374, CE (EN 55022 Class A, EN 55024), CCC, BSMI, KCC
Supply Voltage	100-240 VAC, 1.6 A
Supply Frequency	50 Hz/60 Hz
Warranty	Printer - Two years; Printhead - Two years, unlimited pass with UltraCard®
Encoding Options Supported	125kHz (HID Prox) reader 13.56 MHz (iCLASS, MIFARE, ISO 14443 A/B, ISO 15693) read/write encoder Contact Smart Card Encoder reads from and writes to all ISO7816 1/2/3/4 memory and microprocessor smart cards (T=0, T=1) as well as synchronous cards ISO Magnetic Stripe Encoding, dual high- and low-coercivity, Tracks 1, 2 and 3

Term	Function
Options	Single wire Ethernet and USB 2.0 Interface for inline printing and encoding Single wire Ethernet encoding is only available for iCLASS and Contact Smart Card encoding Dual-Sided Printing Module - Upgradable Dual Input Card Hopper - Upgradable (DTC4250e) Same-Side Input / Output Card Hopper - Upgradable (DTC4250e) Smart Card Encoding (contact/contactless) - Upgradable Magnetic Stripe Encoding - Upgradable Printer Clearing Kit
Software	FARGO Workbench Diagnosis Utility
Display	Color changing status buttons (DTC1250E, DTC4250E) Graphical Display (DTC4250E)

1.4 Functional Specifications

This card printer utilizes two different, yet closely related printing technologies to achieve its remarkable direct-to-card print quality for dye-sublimation and resin thermal transfer.

1.5 Printer Components: Print Ribbons

The card printer utilizes both dye-sublimation and/or resin thermal transfer methods to print images directly onto blank cards. Since the dye-sublimation and the resin thermal transfer print methods each provide their own unique benefits, print ribbons are available in resin-only, dye-sublimation-only and combination dye-sublimation/resin versions.

To make it easier to remember which print ribbons are which, a letter code has been developed to indicate the type of ribbon panels found on each ribbon. This letter code is as follows:



= Dye-Sublimation Yellow Panel



= Dye-Sublimation Magenta Panel



= Dye-Sublimation Cyan Panel



= Resin Black Panel (Premium unless otherwise stated)

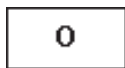

= Clear Protective Overlay Panel



= Fluorescing Panel

1.5.1 Ribbon Types and Print Counts

The following table includes the ribbon types and typical print counts.

Ribbon	DTC1250e	DTC1000Me	DTC4250e
YMCKO - Full Color/Resin Black / Overlay	500	N/A	500
YMCKO Half Panel - Full Color (1/2) / Resin Black/Overlay	850	N/A	850
YMCFKO - Full Color/UV Fluorescing / Resin Black / Overlay	N/A	N/A	500
YMCKK - Full Color / 2 Resin Black	N/A	N/A	N/A
YMCKOK - Full Color / 2 Resin Black / Overlay	500	N/A	500
YMCFKOK - Full Color/UV Fluorescing / 2 Resin Black / Overlay	N/A	N/A	400
YMCKOK - Half Panel-Full Color (1/2) / 2 Resin Black / Overlay	850	N/A	N/A
YMCKOKO - Half Panel-Full Color (1/2) / 2 Resin Black / 2 Overlay	850	N/A	N/A
K - Standard Resin	3000	3000	3000
K - Premium Resin	3000	3000	3000
Colored Resin	2000	2000	2000
KO - Premium Black Resin / Overlay	1250	1250	1250
BO - Dye-Sub Black / Overlay	1250	1250	1250
None - Rewritable	Supported	Supported	Supported

1.6 Printer Components: Blank Cards

Type	Description
Card Size	The Card Printer accepts standard CR-79 and CR-80 sized cards.
Card Surface	<p>Suitable cards must have a polished PVC surface free of fingerprints, dust or any other types of embedded contaminants. In addition, cards must have a completely smooth, level surface in order for the printer to achieve consistent color coverage. Certain types of Proximity cards have an uneven surface that will inhibit consistent color transfer.</p> <p>Certain types of smart card chips are raised slightly above the cards surface which also results in poor color transfer.</p>
UltraCard Brand Cards	<p>The UltraCard product line, available exclusively as part of HID Global FARGO brand secure card issuance solutions, has a long standing reputation among dealers and end-Users for consistent quality in construction.</p> <ul style="list-style-type: none"> • In addition to blank stock, the UltraCard line is available in a variety of configurations for magnetic stripe, custom holograms and other additional anti-counterfeiting feature • UltraCard Premium is the preferred card for Direct-to-Card (DTC) applications that require a higher quality card. The UltraCard Premium's composite material construction provides for maximum durability, flexibility and card life, with optimal resolution print quality for lamination and fluorescent panel Ribbon printing applications. • UltraCard PVC cards are medium-durability cards for a glossy, photo quality finish. These cards are manufactured to ensure clean, scratch-free cards for high-quality prints and extended Printhead life.

This page intentionally left blank.

Setup and Installation Procedures

This section describes the setup and installation for the DTC1250e, DTC1000Me, and the DTC4250 Card Printers.

2.1 Choosing a Good Location

The following guidelines help to ensure optimal printing performance:

- Place the unit in a location with adequate air circulation to prevent internal heat buildup.
- Use the printer's dimensions as a guideline for the minimum clearances to the unit.
Note: Allow for adequate clearance in front of the unit to accommodate the unit with its covers open.
- Do not install unit near heat sources such as radiators or air ducts or in a place subject to direct sunlight, excessive dust, mechanical vibration or shock.

2.1.1 About Moisture Condensation

If the unit is brought directly from a cold to a warm location or is placed in a very damp room, moisture may condense inside the unit. Should this occur, print quality may not be optimal.

Leave the unit unplugged in a warm, dry room for several hours before using to evaporate any moisture.



Caution: For safety purposes, Ethernet is not intended for a direct connection outside of the building.

Attention: Pour des raisons de sécurité, Ethernet n'est pas conçu pour une connexion directe à l'extérieur du bâtiment.

2.2 Unpacking and Inspection

While unpacking your Printer, inspect the carton to ensure that no damage has occurred during shipping. Make sure that all supplied accessories are included with your unit.

Check that the following items are included:

- Power Supply
- US/EU Power Cable
- USB cable (2.0)
- Software Installation CD
- Card Printer User Guide
- Warranty Statement, Compliance Document

2.3 Installing the Print Ribbon Cartridge

FARGO Direct-to-Card Printers require highly specialized supplies to function properly.

The FARGO DTC1250e, DTC1000Me, and DTC4250e Card Printers use a one piece, disposable ribbon cartridge system.

To maximize printer durability, reliability and printed card quality, only FARGO-certified supplies must be used. For this reason, your FARGO warranty is void, where not prohibited by law, if you use non-FARGO-certified supplies.

Printer cleaning is recommended with each ribbon change to ensure quality printed cards.

Resin-only print ribbons consist of a continuous roll of a single resin color. No protective overlay panel (O) is provided because resin images do not require the protection of an overlay.

2.3.1 Installing the Ribbon

1. Pull open front cover.
2. Insert the print ribbon cartridge into the printer.

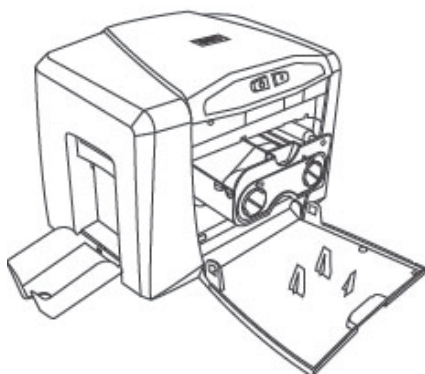

DTC1250e/DTC1000Me

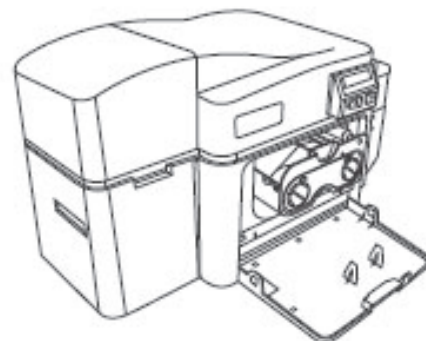

DTC4250e with Flipper Module

3. Close the front cover.



DTC1250e/DTC1000Me



DTC4250e with Flipper Module

2.4 Installing Blank Cards into the Input Card Hopper

The FARGO DTC1250e, DTC1000Me and DTC4250e Card Printers are capable of printing single feed cards and multiple feed cards (batch mode). To print a single feed card, remove all cards from the input card hopper, leave its door closed and place a card in the single feed card slot (which can be used repeatedly).

1. Load the cards with the print side down and (if applicable) the magnetic strip up and towards the front of the printer.

Information: Do not run the cards with a contaminated, dull or uneven surface through the Printer. Printing onto these cards may lead to poor print quality and can greatly reduce the life of the printhead.

- Card types include PVC or PVC finish.
- Cards eject into the output hopper or reject hopper.
- Each input hopper holds 100 cards.
- Certain types of smart card chips are raised slightly above the cards surface, which may result in poor color transfer. Design the card with white space surrounding the chip.

2. Open the input card hopper door.

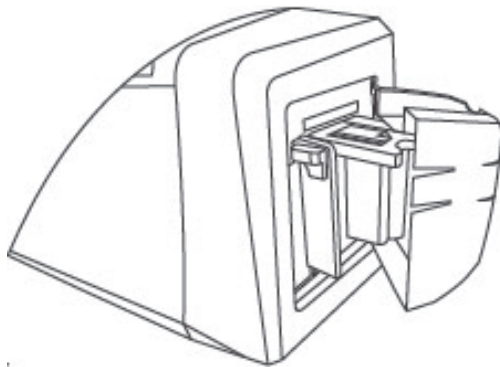

3. Press the card hopper load lever down until the card tray locks into place.

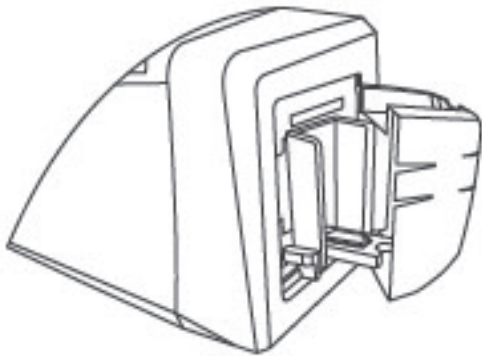

4. Load up to 100 cards into the hopper with the print side down. If using cards with a magnetic stripe, the magnetic stripe should be loaded with the stripe up and to the front of the Printer.

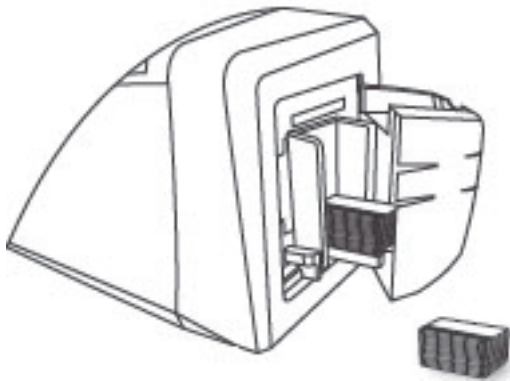

5. Close the input card hopper door to release the lever to the printing position.

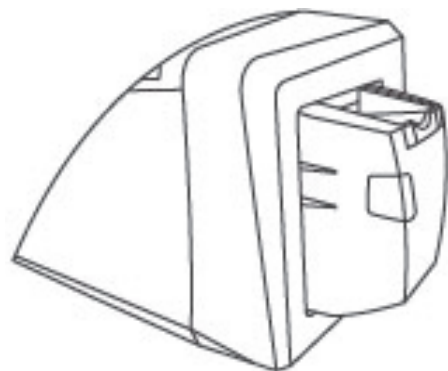

2.5 Card Size Selection

The printer uses standard size CR-70 and CR-80 cards.

Follow this procedure in the printer and in the printer driver to setup the card size.

1. Open the front door and locate the slide bar.



2. If using the CR-79 card, push the slide bar to the LEFT.



3. If using the CR-80 card, push the slide bar to the RIGHT.



4. From the Driver Printing Preferences, select the correct card size.

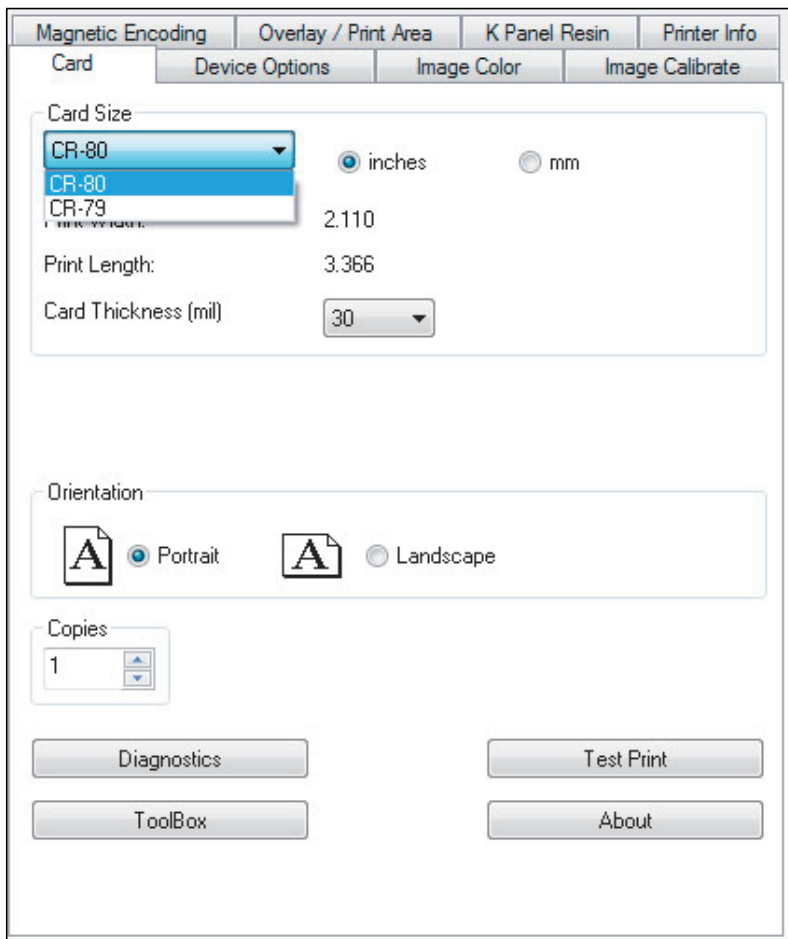

2.6 Connecting the Printer Power

To connect power to the printer, follow this procedure.

Note: Do not connect the printer's USB cable until prompted during the printer driver installation.

1. Plug the AC adapter power cable into the back of the printer.



2. Plug the wall power cable into the AC power adapter.
3. Plug the wall power cable into a standard 100-240VAC power outlet.
4. Press the printer's power button to power on the printer.

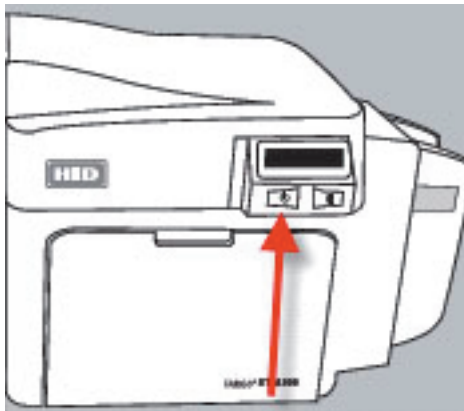

Note: The printer powers down during the “sleep time” but automatically powers up when a print job is sent.

This page intentionally left blank.

Print Driver Installation

3.1 Print Driver Installation

This section describes the printer driver installation requirements and standard procedures. Requirements are listed below. The DTC1250e, DTC1000Me, and DTC4250e Print Driver supports the following:

- Windows Vista 32 bit with SP2
- Windows Vista 64 bit with SP2
- Windows XP 32 bit with SP3
- Windows Server 2003 (R1) 32 bit
- Windows Server 2008 (R1) 32 bit with SP2
- Windows Server 2008 (R1) 64 bit with SP2
- Windows Server 2008 R2
- Windows 7 32 bit and 64 bit
- Windows 8 32 bit and 64 bit

For more information on supported operating systems, see hidglobal.com/support.

3.2 Driver Installation Instructions

Start the installation process by inserting the Driver CD into the computer; then, follow the Installaware Wizard screen prompts.

1. Select **Install the Printer Driver** to start the driver installation.
2. Select the **FARGO Workbench Utility Program** to install the Diagnostic program.
3. All versions of Windows require **Administrator** rights.
4. From the *Printer & Faxes*, select **Printing Preferences** to setup the printer driver after it has been installed.
5. Use the drop-down arrows to select the correct options for each printing preference.

Chapter 4

Printer Preferences

This section provides an overview of the Printing Preferences tabs.

4.1 Card Tab

The **Card** tab provides options that define the basic characteristics of a card – the size and orientation. The **Card** tab also provides access to helpful utilities and information:

- Diagnostics
- Test Print
- Toolbox
- About

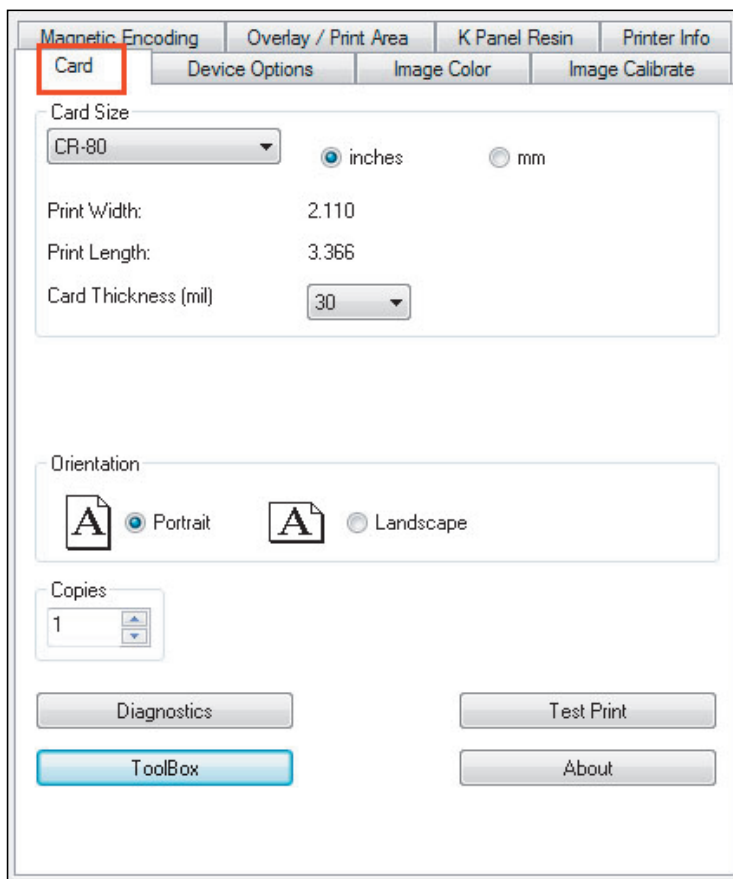

Field	Description
Card Size	Select CR-80 or CR-79.
Measurement units	Select inches or mm (millimeters).
Print Width	Displays width dimension of the card.
Print Length	Displays length dimension of the card.
Card Thickness (mil)	Select the card thickness in mils.
Orientation	Select Portrait for vertical orientation or Landscape for horizontal orientation.
Copies	Select the number of copies to print using Test Print.
Diagnostics	Click Diagnostics to access the Workbench 3 utility. See the <i>Workbench 3 User Guide</i> or <i>Workbench 3 Help</i> facility for more information. See <i>Section 4.1.1: Toolbox Window</i>
Test Print	Click Test Print to send one or more self-test prints to the printer.
Toolbox	Click the Toolbox button for access to the following Toolbox options: <ul style="list-style-type: none"> • Configuration • Calibrate Ribbon • Clean Printer • Advanced Settings
About	

4.1.1 Toolbox Window

The Card Toolbox window is displayed with the selection of the **Toolbox** button on the **Card** tab.

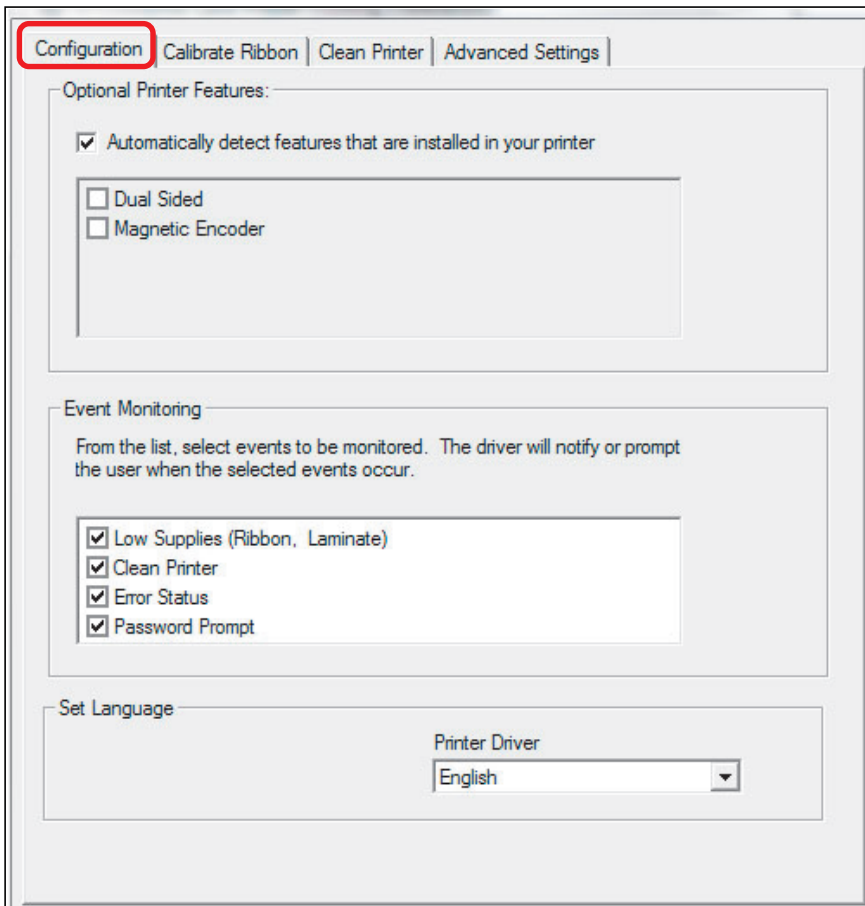

4.1.1.1 Configuration Tab

The Toolbox **Configuration** tab is used to show the currently installed Optional Printer features, Event Monitoring, to set the Printer Driver language and Printer Display language.

Set Language

To switch between languages, select the preferred language from the **Printer Driver** drop-down menu. Click **OK** twice, and then open the driver in the preferred language.

4.1.1.2 Calibrate Ribbon Tab

The Toolbox **Calibrate Ribbon** tab will send the Calibrate Ribbon command to printer when the user clicks the **Calibrate** button.

Follow the procedure displayed on this window.

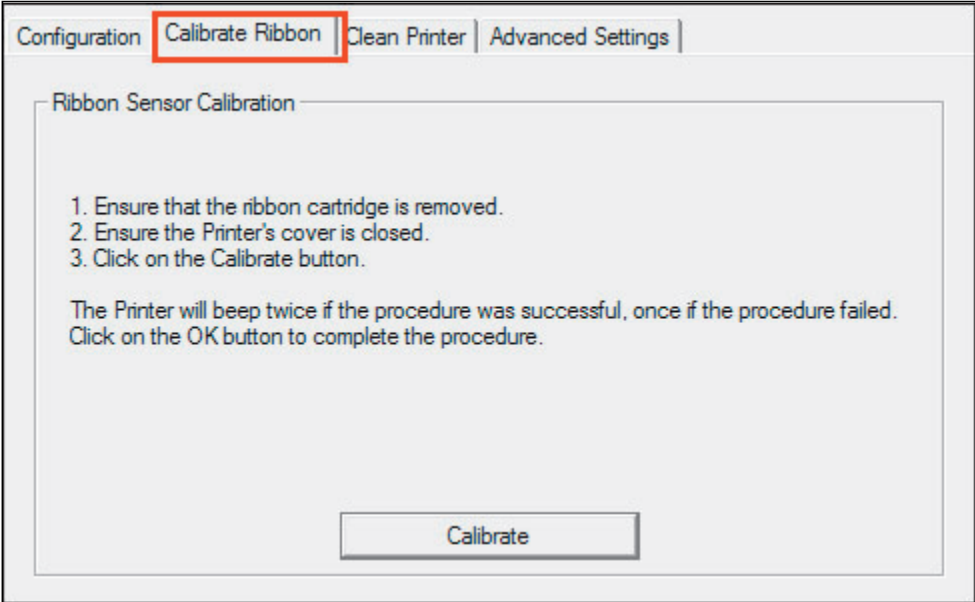

4.1.1.3 Clean Printer Tab

The Toolbox **Clean Printer** tab will launch the cleaning routine when the user clicks the **Clean** button.

Follow this procedure displayed on this window.

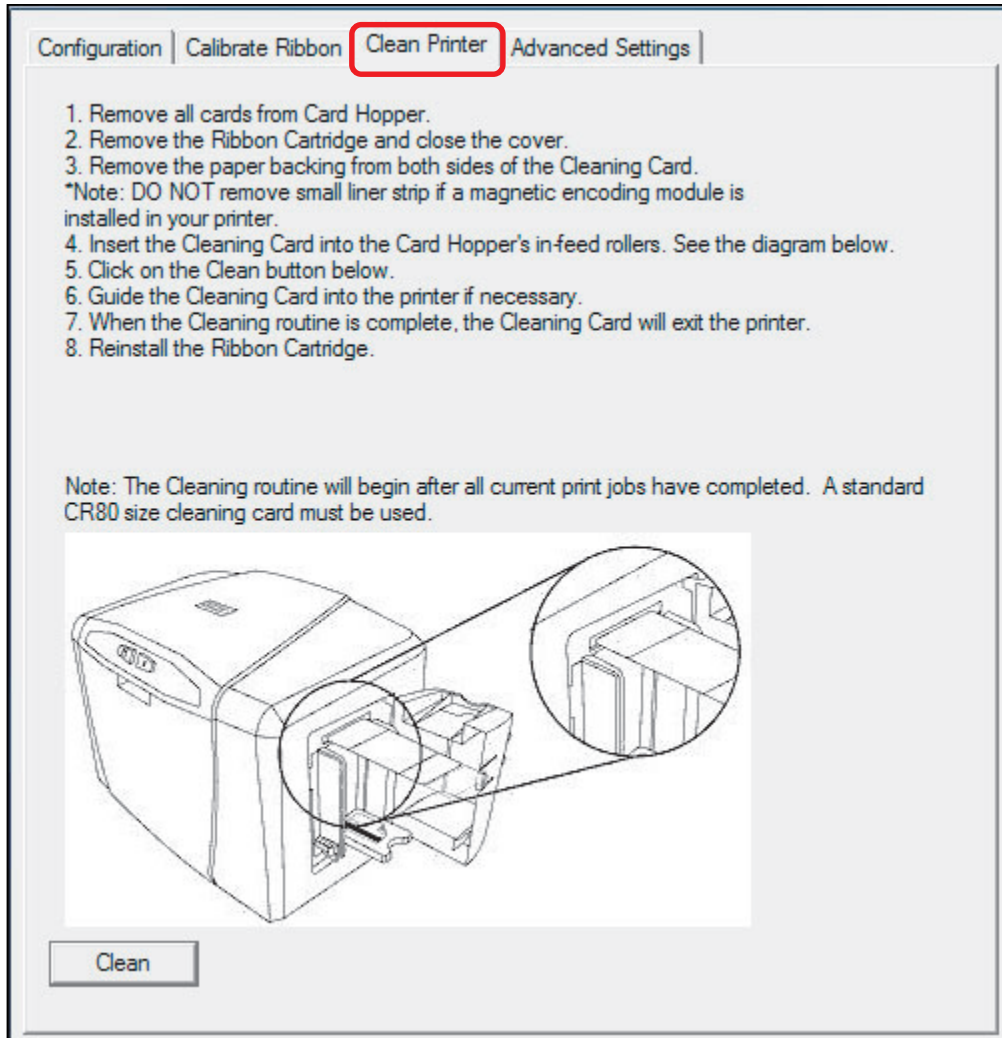

Configuration | Calibrate Ribbon | **Clean Printer** | Advanced Settings

1. Remove all cards from Card Hopper.
2. Remove the Ribbon Cartridge and close the cover.
3. Remove the paper backing from both sides of the Cleaning Card.
*Note: DO NOT remove small liner strip if a magnetic encoding module is installed in your printer.
4. Insert the Cleaning Card into the Card Hopper's in-feed rollers. See the diagram below.
5. Click on the Clean button below.
6. Guide the Cleaning Card into the printer if necessary.
7. When the Cleaning routine is complete, the Cleaning Card will exit the printer.
8. Reinstall the Ribbon Cartridge.

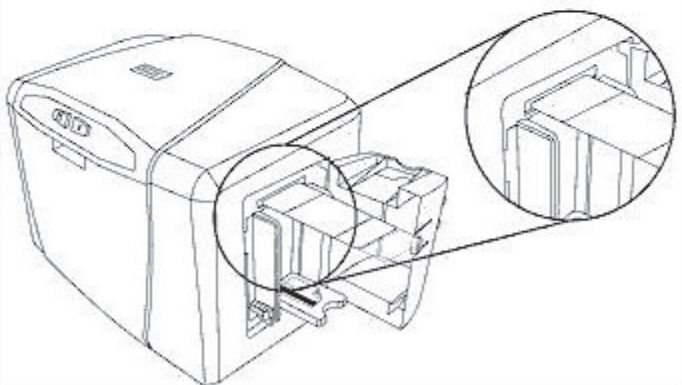

Note: The Cleaning routine will begin after all current print jobs have completed. A standard CR80 size cleaning card must be used.



Clean

4.1.1.4 Safety Messages (Review Carefully)

Note: All messages are provided in English and French.

Symbol	Critical Instructions for Safety Purposes
	<p>Danger: Failure to follow these installation guidelines can result in death or serious injury. Information that raises potential safety issues is indicated by a warning symbol (as shown to the left).</p> <ul style="list-style-type: none"> • To prevent personal injury, refer to the following safety messages before performing an operation preceded by this symbol. • To prevent personal injury, always remove the power cord prior to performing repair procedures, unless otherwise specified. • To prevent personal injury, make sure only qualified personnel perform these procedures.
	<p>Attention: Le non respect de ces consignes d'installation peut entraîner la mort ou des blessures graves. L'information qui pose des problèmes de sécurité potentiels sont signalées par un symbole d'avertissement (comme illustré à gauche).</p> <ul style="list-style-type: none"> • Pour éviter toute blessure, consultez les consignes de sécurité suivantes avant d'effectuer une opération précédée par ce symbole. • Pour éviter toute blessure, débranchez toujours le cordon d'alimentation avant d'effectuer les procédures de réparation, sauf indication contraire. • Pour éviter toute blessure, assurez-vous que seul le personnel qualifié est chargé de ces procédures.
	<p>Caution: This device is electrostatically sensitive. It may be damaged if exposed to static electricity discharges. Information that raises potential electrostatic safety issues is indicated by a warning symbol (as shown to the left).</p> <ul style="list-style-type: none"> • To prevent equipment or media damage, refer to the following safety messages before performing an operation preceded by this symbol. • To prevent equipment or media damage, observe all established Electrostatic Discharge (ESD) procedures while handling cables in or near the circuit board and printhead assemblies. • To prevent equipment or media damage, always wear an appropriate personal grounding device (e.g., a high quality wrist strap grounded to avoid potential damage). • To prevent equipment or media damage, always remove the Ribbon and Cards from the Printer before making any repairs, unless otherwise specified. • To prevent equipment or media damage, take jewelery off of fingers and hands, as well as thoroughly clean hands to remove oil and debris before working on the printer.



Symbol	Critical Instructions for Safety Purposes
	<p data-bbox="407 289 532 317">Attention:</p> <p data-bbox="407 323 1468 380">Ce dispositif est sensible aux décharges électrostatiques. Il peut être endommagé s'il est exposé à des décharges d'électricité statique.</p> <p data-bbox="407 386 1511 443">Informations qui soulève des questions de sécurité potentiels électrostatiques est indiqué par un symbole d'avertissement (comme illustré à gauche).</p> <ul data-bbox="440 449 1511 877" style="list-style-type: none"><li data-bbox="440 449 1511 537">• Pour éviter que l'équipement ou les dommages des médias, reportez-vous aux consignes de sécurité suivantes avant d'effectuer une opération précédée par ce symbole.<li data-bbox="440 543 1511 627">• Pour éviter que l'équipement ou des dommages médias, observer tous décharge établie électrostatique (ESD) des procédures lors de la manipulation des câbles à ou près de la carte de circuit imprimé et assemblées de la tête d'impression.<li data-bbox="440 634 1511 718">• Pour éviter que l'appareil ou un support endommagé, portez toujours un dispositif approprié de mise à la terre personnelle (par exemple, un bracelet de haute qualité à la terre pour éviter les dommages potentiels).<li data-bbox="440 724 1511 781">• Pour éviter que l'appareil ou un support endommagé, retirez toujours le ruban et les cartes de l'imprimante avant d'effectuer des réparations, sauf indication contraire.<li data-bbox="440 787 1511 877">• Pour éviter que l'équipement ou les dommages des médias, prendre des bijoux hors de doigts et les mains, ainsi que les mains propres pour enlever l'huile et les débris avant de travailler sur l'imprimante.

4.1.1.4.1 Cleaning Kit

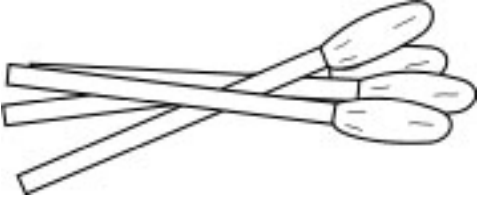

As with any electronic device, internal components of the printer, such as the printhead, may be damaged if exposed to static electrical discharges. To avoid potential damage, always wear an appropriate personal grounding device, such as a wrist strap (with integral resistor) connected to an ESD ground.

This Cleaning Kit provides you with the specialized cleaning supplies and the required cleaning procedures for you to maintain your card printer/encoder. The following cleaning procedures will require less than 10 minutes.

Description	Supplies (pictured)
<p>Four (4) Printhead Cleaning Swabs are pre-moistened with 99.99% isopropyl alcohol for cleaning your printer's printhead.</p>	
<p>Three (3) Alcohol Cards are pre-moistened with 99.99% isopropyl alcohol for cleaning your printer's platen, and card feed rollers.</p>	
<p>Ten (10) Cleaning Cards are provided with adhesive backing for cleaning your printer's platen and card feed rollers.</p>	

4.1.1.4.2 Printhead Cleaning

1. Turn Off the printer and unplug the power cord from the printer.
2. Remove the ribbon cartridge.
3. Open the Printhead Cleaning Swabs. Break it to moisten the tip.
4. Swab the tip back and forth across the top of the printhead.
5. Allow to dry thoroughly before sending a print job.



4.1.1.4.3 Cleaning the Platen and the Card Feed Rollers

Perform this procedure approximately every 1000 prints to maintain a consistent print quality.

Note: The card feed rollers move the card throughout the print process. Rollers should be kept clean to prevent card jams and card contamination. This cleaning process will ultimately lead to better print quality and extended printhead life.

1. Open the printer's front cover, remove the print ribbon and close the front cover.
2. Remove all the cards from the printer's input card hopper.



3. Use the cleaning card from the cleaning kit and remove the adhesive backing from both sides of the card.
 - If your printer has a magnetic encoder installed, be sure to leave the small liner strip on top of the cleaning card in place.
 - This small strip is needed to protect the magnetic head from the adhesives on the cleaning card.



4. Insert the cleaning card into the single feed card slot until the card stops.
If your printer is equipped with a magnetic encoder, you must insert the cleaning card with the printed side up and with the small liner strip towards the front of the printer.

5. From your computer, open the Printer Driver and select **Printing Preferences > Card tab > ToolBox**.

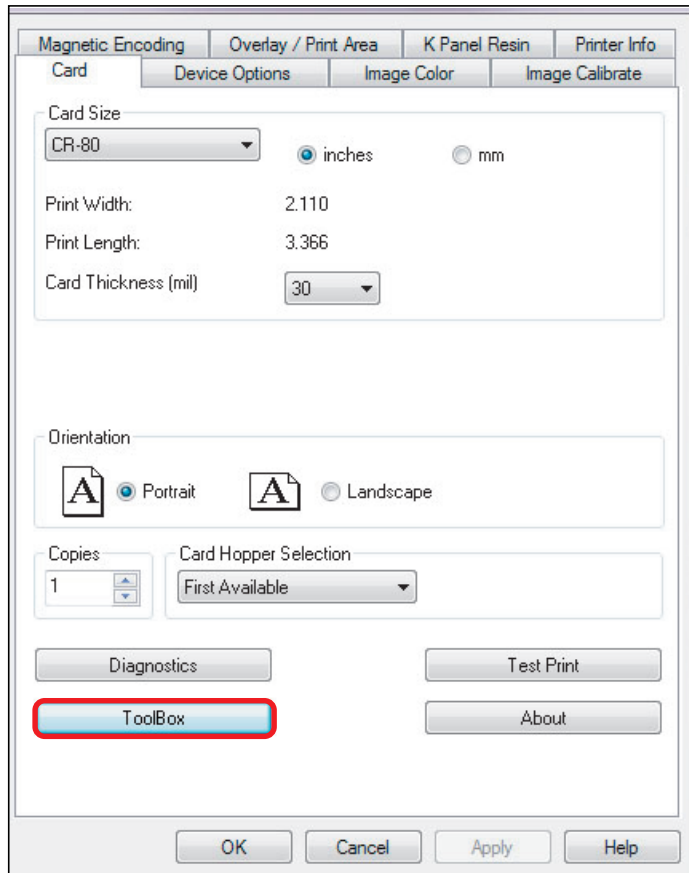

6. Select the **Clean Printer** tab.

7. Click **Clean**.

- The printer pulls in the cleaning card. The printer performs the automated cleaning procedure.
- This procedure is designed to thoroughly clean the platen and the card feed rollers inside the printer.

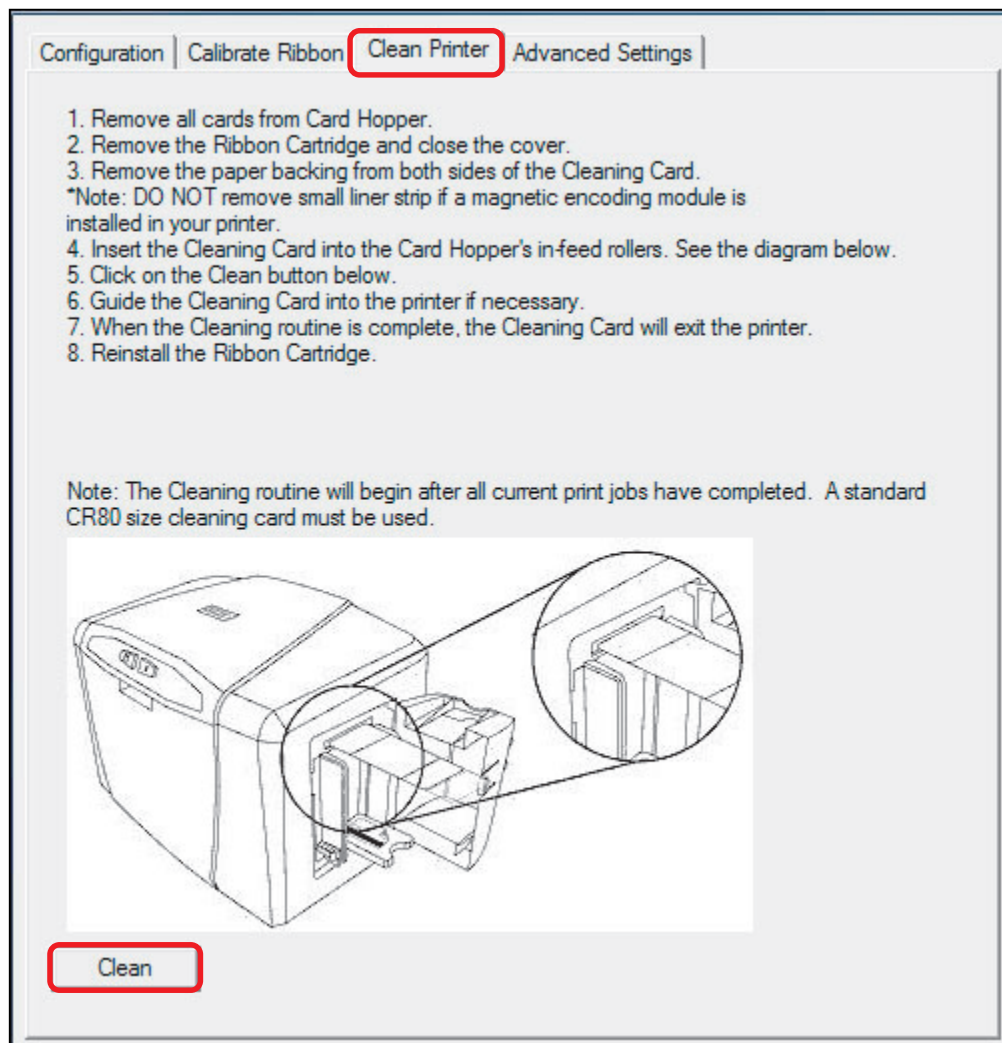

4.1.1.4.4 Cleaning the Printer's Exterior

Clean the printer with a microfiber cloth only. Do not drip water into the printer. Dry thoroughly before printing.

Note: The printer has a durable casing that should retain its luster and appearance for many years.

4.1.1.5 Advanced Settings Tab

Use the Toolbox **Advanced Settings** tab for adjusting the internal printer settings, which are customized for every printer at the factory and saved directly within the printer's memory.

Note: Select **Restore Defaults** to restore the internal default settings.

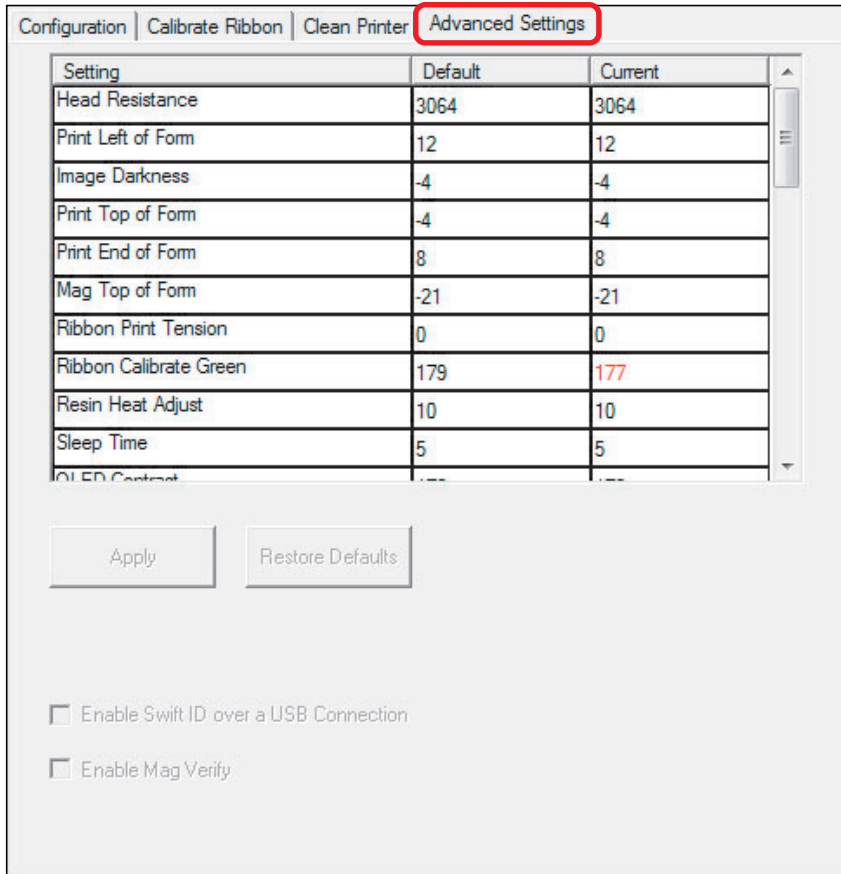

Setting	Default	Current
Head Resistance	3064	3064
Print Left of Form	12	12
Image Darkness	-4	-4
Print Top of Form	-4	-4
Print End of Form	8	8
Mag Top of Form	-21	-21
Ribbon Print Tension	0	0
Ribbon Calibrate Green	179	177
Resin Heat Adjust	10	10
Sleep Time	5	5
OLEF Control	---	---

Apply Restore Defaults

Enable Swift ID over a USB Connection

Enable Mag Verify

Settings enable users to change the values for firmware settings by clicking on the Current column.

Field	Description
Setting Column	Displays label for setting. See the Setting Column Fields table below.
Default Column	Displays default value for setting
Current Column	Displays current value for setting
Apply Button	Applies changed values.
Restore Defaults Button	Restores the default values.
Enable Mag Verify	Check this box to verify that the data is written to the tracks correctly.

Setting Column Fields

Field	Description
Head Resistance	This is factory set. If the main board or the Printhead is replaced, then adjust this number. Locate the Printhead Setting Number on the bottom of the Printhead. The number reads R=XXXX.
Print Left of Form	Use this option to adjust the vertical position of the printed image on the card; so it appears centered. Maximum Adjustment Range is +/- 127. Each increment equals .01".
Image Darkness	Use this option to set the overall darkness of the printed image by increasing or decreasing the amount of heat (used by the Printhead when printing). Note: If the value is set too high, the Ribbon may jam or even break.
Print Top of Form	Use this option to adjust the length-wise or horizontal position of the printed image on the card (so it appears to be centered). Note: If the negative value is set too high, the Print Ribbon may break.
Mag Top of Form	Use this option to shift the starting point where the Printer begins to encode the magnetic track data on the card's Magnetic Stripe. Note: If the negative value is set too high, the Printer may start encoding before the Magnetic Stripe reaches the encoding head. Maximum adjustment range is +/- 80. Each increment equals .01".
Ribbon Print Tension	Use the Ribbon Tension option to increase or decreases the amount of tension (drag) on the Ribbon during printing.
Ribbon Calibrate Green	This is a calibration driven value and should not be adjusted. Note: This is factory set and should not be changed unless directed by a technician.
Resin Heat Adjust	Use this adjustment for Black premium resin text and bar codes if they appear faded, too light or too dark. Maximum Adjustment Range is +/- 100. Note: This control can be helpful for fine-tuning the transfer of resin text and bar codes.
Sleep Time	The Sleep Time setting adjusts the number of minutes of inactivity before the Printer enters a low power sleep state.
OLED Contrast (display contrast)	Use this option to increase or decrease the contrast of the printer OLED (if applicable).
Ribbon Calibrate Blue	This setting is a calibration driven value and should not be adjusted. It is factory set and should not be changed unless directed by a technician.
Cleaning Rate	Use this option to adjust the number of cards printed before the Printer displays a message indicating cleaning is needed. The default value is 3000 cards.
Mag HI-Co Voltage Offset	This setting is a calibration driven value and should not be adjusted. It is factory set and should not be changed unless directed by a technician.
Mag Lo-Co Voltage Offset	This setting is a calibration driven value and should not be adjusted. It is factory set and should not be changed unless directed by a technician.

Field	Description
Ribbon Green LED Level	This setting is a calibration driven value and should not be adjusted. It is factory set and should not be changed unless directed by a technician.
Ribbon Blue LED Level	This setting is a calibration driven value and should not be adjusted. It is factory set and should not be changed unless directed by a technician.
Erase Heat Offset	Adjust the Erase temperature for the rewritable cards as needed. Increase the Current Setting to cause more heat to be used in the erasing process. OR Decrease the Current Setting to cause less heat to be used in the erasing process. Note: Erase Heat Offset provides user ability to control the Printhead heat level when the Erase Operation is performed. Appropriate heat levels should be applied for the proper erase process. This setting should be adjusted for proper erasure.
Write Heat Offset	Adjust the Write temperature for the rewritable cards as needed. Increase the Current Setting to cause more heat to be used in the printing process of a rewritable card. OR Decrease the Current Setting to cause less heat to be used in the printing process of a rewritable card. Note: Write Heat Offset provides user capability to control the printhead heat level when the Write Operation is performed. Appropriate heat levels should be applied for the proper writing process.
Flipper Home Offset	This setting is a calibration driven value and should not be adjusted. If the Flipper unit is replaced and has not been calibrated this value may need to be adjusted. This setting is factory set and should not be changed unless directed by a technician.
Flipper Eject Height Offset	This setting is a calibration driven value and should not be adjusted. If the Flipper unit is replaced and has not been calibrated this value may need to be adjusted. This setting is factory set and should not be changed unless directed by a technician.
Mag Super-Co Voltage Offset	This option changes the voltage going the magnetic head. This setting is factory set and should not be changed unless directed by a technician.
Mag Medium-Co Voltage Offset	This option changes the voltage going the magnetic head. This setting is factory set and should not be changed unless directed by a technician.
Head Home Offset	This setting is a calibration driven value and should not be adjusted. If the Printhead assembly is replaced then this value may need to be adjusted. This setting is factory set and should not be changed unless directed by a technician
Head Print Offset	This setting is a calibration driven value and should not be adjusted. If the printhead assembly is replaced then this value may need to be adjusted. This setting is factory set and should not be changed unless directed by a technician.

Field	Description
Head Contact Offset	This setting is a calibration driven value and should not be adjusted. If the printhead assembly is replaced then this value may need to be adjusted. This setting is factory set and should not be changed unless directed by a technician.
Head Queue Offset	This setting is a calibration driven value and should not be adjusted. If the printhead assembly is replaced then this value may need to be adjusted. This setting is factory set and should not be changed unless directed by a technician.
Head Card Thickness Offset	Adjusts the card handling path to allow for variances in card thickness.
Head Smart Card Engage Offset	Adjusts the position of the print head to allow smart card encoder contact.
Head Mag Offset	Adjusts the printhead for magnetic encoding.
Overlay Heat Adjust	Adjusts the temperature setting for overlay film.
10 Mil Card Queue Offset	Adjusts the input queue for use with thick cards.
Erase Speed	Adjusts the speed of the erasure process.
Standard Resin Head Adjust	Use this adjustment for Black standard resin text and bar codes if they appear faded, too light or too dark. Maximum Adjustment Range is +/- 100. This control can be helpful for fine-tuning the transfer of resin text and bar codes.
Printhead Smart Cue Offset	Adjusts the card handling path to allow for variances in card thickness.

4.2 Device Options Tab

The **Device Options** tab configures the Supplies, Dual Sided and Options features.

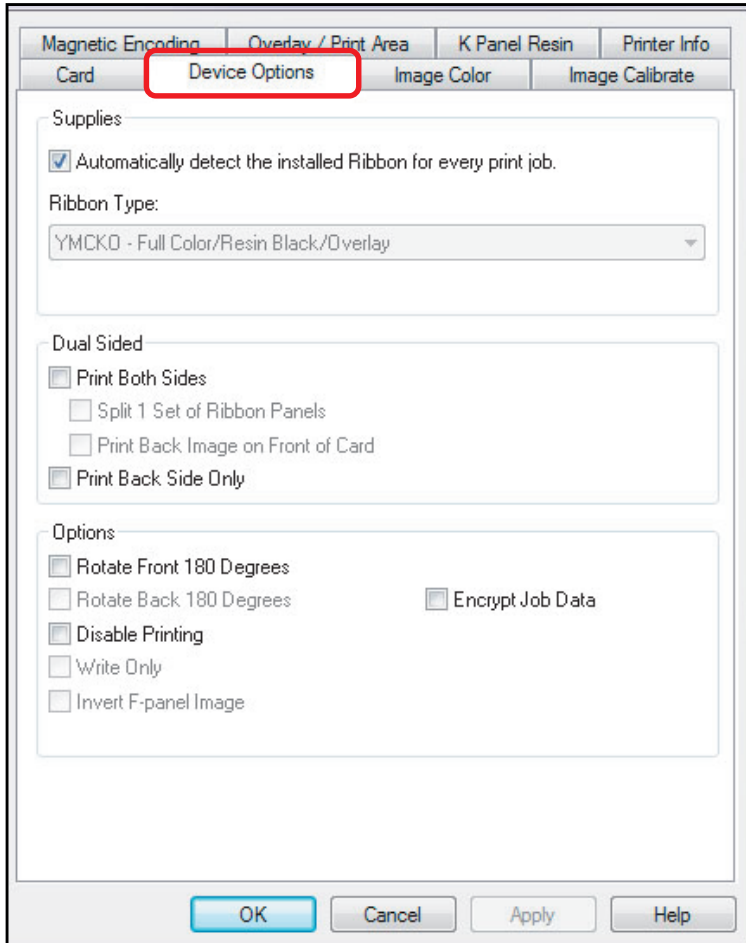

Field	Description
Supplies	
Automatically detect the installed Ribbon for every print job	To verify that the ribbon type selected matches the installed ribbon. The printer changes the ribbon type to the correct setting. The dialog indicates that the current setting has changed or that the current ribbon type is correct.
Ribbon Type	Manually selects the ribbon type. The available choices will vary, based on compatibility with your printer model. For rewritable cards, select None - Re-Writable .

Field	Description
Dual Sided	
Note: The Dual Sided area is grayed out when the printer is single-sided only.	
Print Both Sides	Select to automatically print the front and back sides of the card. Split 1 Set of Ribbon Panels - Select to automatically print the front and back sides of the card using one ribbon panel. Print Back Image on Front of Card - Select to print the first page of a two-page print file on the card's backside. This option can also be used to print black resin on a smart card's chip side. Note: The second page of the file is printed on the card's front side.
Print Back Side Only	Select to print only on the card's back side.
Options	
Rotate Front 180 Degrees	Select to change the orientation of the first page of the card design to accommodate the location of a chip or RFID sensor.
Rotate Back 180 Degrees	Select to change the orientation of the second page of the card design to accommodate the location of a chip or RFID sensor.
Disable Printing	Click to prevent the printer from printing.
Write Only	Select to use rewritable cards. The default setup is for the printer to first erase the entire card and then write new information on the card. There is no option to select specific areas to erase. However, to print or erase a section, use the Overlay/Print Area tab. Select the specific area in the same manner as a print job with a color ribbon. To erase many cards, use the FARGO Workbench Re-Writable Card Eraser option. It does not print. It only erases. Note: No ribbon is used with rewritable cards. Do not load a ribbon into the printer when using this process. Printing on a rewritable card with a ribbon will ruin the card.
Invert F-panel Image	Select to change the portion of an image that is printed using a fluorescent film panel.
Encrypt Job Data	Select to encrypt information about the print job for enhanced security.

4.2.1 Fluorescent Panels

Fluorescent dye color is bright when black light is applied to it. The YMCFKO/YMCFKOK ribbon is an economical way to add a fully customizable, incremental level of security to your photo identification cards.

4.2.1.1 Selecting the Fluorescent Panel Ribbon Type (DTC4250e only)

This process allows you to configure the data that is printed with the fluorescent panel of an YMCFKO/YMCFKOK Ribbon.

Note: Any software program may be used to print the special florescent panel of the Ribbon to a card once the driver and Workbench are set up correctly.

These ribbons contain a yellow (Y), magenta (M), cyan (C), and resin black (K) panels to create a full color over-the-edge printing identification card. In addition, the ribbon contains a dye-based fluorescing panel (F) which will allow you to print a standard or one-to-one personalized fluorescing image that is completely invisible until exposed to ultraviolet light.

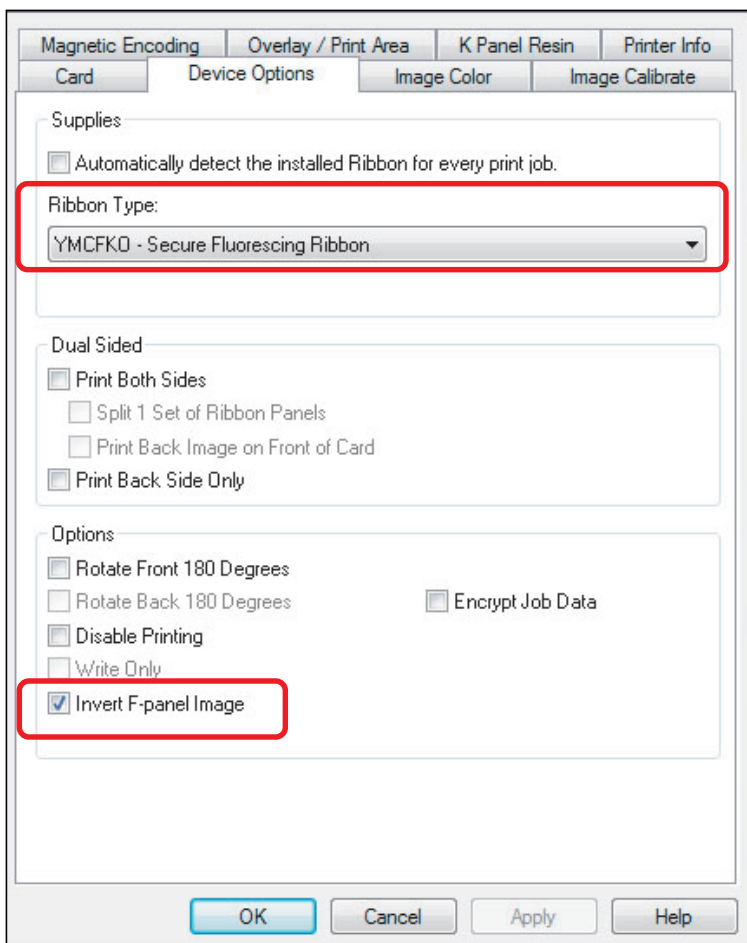

Select **Invert F-Panel Image** to create a negative of the fluorescent image. This option refers to the ability to cause light or white areas of the image to fluoresce and for dark colors to remain dark on the printed card when exposed to an ultraviolet light. By default, the dark areas of the image fluoresce on the card. Lighter or white areas have no dye applied.

4.2.1.2 Creating a Custom Fluorescent Image using the YMCFKO Ribbon

There are three methods used to accomplish the creation of a custom fluorescent image when using the YMCFKO Ribbon.

Printer Driver Method: The fluorescent panel image can be configured directly from the badge application software.

Note: You can now print a unique fluorescent image, such as the card holder’s picture on each card.

Asure ID Method: This method is described in the Asure ID Software User Guide. See the procedure relating to the Fluorescent Panel Ribbon. For more detailed information visit the HID Global support website.

Workbench Method: This method is described in the Workbench User Guide and the Help facility. See the User Guide on your CD. For Help, enter Workbench by clicking the Diagnostics button from the Card tab of the Printing Preferences page and select Help.

4.3 Configuring Fluorescent Data using the Application

This process creates a fluorescent image on your card using a simple text string command in your badge application.

Creating Fluorescent Text

1. Create a new text box in your badge application.
2. Type the TEXT that you want to appear as fluorescent and put a ~T before the start of the text with no space after the ~T. The text will start on the card where the ~T begins.

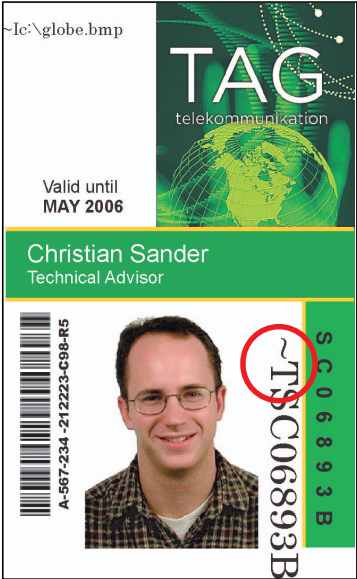

Creating a Fluorescent Image

1. In a separate drawing program, create the image that you wish to fluoresce.



2. Create the IMAGE in the actual size that you want it to appear on the card, and save it as a Grayscale or 1 - bit bmp file on the root c:\ directory.

Note: Do not put spaces in the file name.

3. Create a new text box in your badge application, and type -I followed by the address of your image. The top left of your image will start at the top left of your text box.



4. Set up the printer driver preferences.
5. Set the Ribbon for YMCFKO in the Printing Preferences.

Note: The Automatically detect the installed Ribbon for every print job button may also be used.
6. Select **Invert F-Panel Image** to create a negative of the fluorescent image.
 - This refers to the ability to cause light or white areas of the image to fluoresce and dark colors to remain dark on the printed card when exposed to a UV light.
 - This was requested because the fluorescent dye color is bright when black light is applied to it.

By default, the dark areas of the image will fluoresce on the card and the lighter or white areas will have no dye applied.

Note: This may improve the look of the person's image if used for the Logo.

7. Printer will print the fluorescent BMP IMAGE at the **-I** position on the card. Printer will print the fluorescent TEXT at the **-T** position on the card.

4.4 Image Color Tab

Use the **Image Color** tab to improve the quality of the image on the card. Image Color includes two areas, Image Quality and Heat.

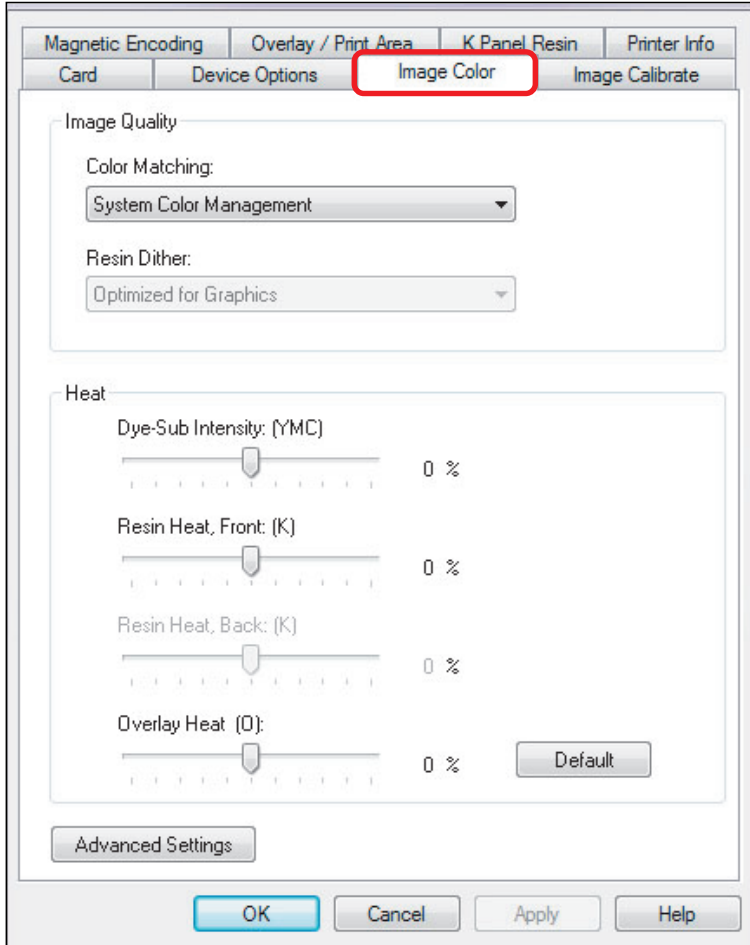

Field	Description
Image Quality	
Color Matching	<p>None - Select:</p> <ul style="list-style-type: none"> • if interested in print speed rather than print color • if color correcting an image that has been previously printed, or • if using third-party color matching software <p>System Color Management - Select to perform color correction through a complex color-matching algorithm. Note: This option shifts colors so they more closely match how they appear on screen.</p> <p>Algebraic - Select to use the Algebraic color-matching algorithm.</p>

Field	Description
Resin Dither	Select the appropriate dither method according to the type of image to be printed. Graphics include images such as drawings, clip art and logos. Photos include images such as photographs and photo-quality images. This option affects objects printed with a resin-only ribbon.
Heat	<p>Dye-Sub Intensity (YMC) – Control the overall darkness and lightness of the dye-sub printed image by moving the slider to the left to use less heat in the printing process, resulting in a lighter print. Move the slider to the right to use more heat, resulting in a darker print.</p> <p>Note: This slide only affects those images printed with dye-sublimation ribbon panels (YMC).</p> <p>Resin Heat, Front (K) – Move the slider to the left to use less heat in the printing process, resulting in a lighter or less saturated print. Move the slider to the right to use more heat, resulting in a darker or more saturated print.</p> <p>Note: This control can be helpful for fine-tuning the sharpness of resin text and bar codes.</p> <p>Resin Heat, Back (K) – Move the slider to the left to use less heat in the printing process, resulting in a lighter or less saturated print. Move the slider to the right to use more heat, resulting in a darker or more saturated print.</p> <p>Overlay Heat (O) – Move the slider to the left to use less heat in the printing process. Move the slider to the right to use more heat.</p>
Default	Click the Default button to return all options to their factory settings.
Advanced Settings	See the Advanced Settings section below.

4.4.1 Advanced Settings

Click the **Advanced Settings** button to display the **Advanced Image Color** window.

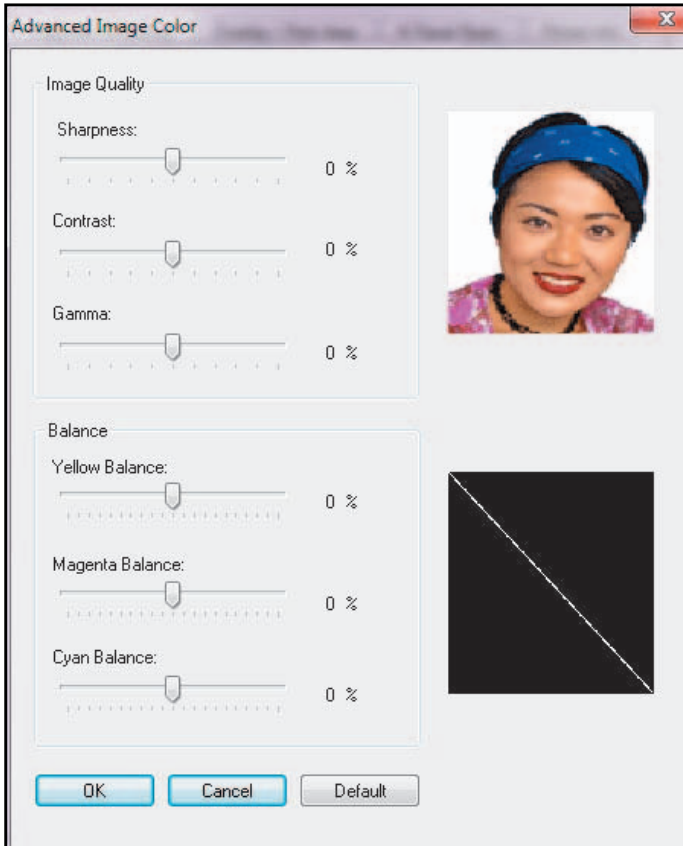

Field	Description
Image Quality	
Sharpness	Move the slider to the right to sharpen the image. Move the slider to the left to decrease sharpness.
Contrast	Move the slider to the right to increase contrast in the image. Move the slider to the left to decrease contrast.
Gamma	Move the slider to the right to increase gamma in the image. Move the slider to the left to decrease gamma.
Balance	
Yellow Balance	Move the slider to the right to increase the amount of yellow in the image. Move the slider to the left to decrease the amount of yellow.
Magenta Balance	Move the slider to the right to increase the amount of magenta in the image. Move the slider to the left to decrease the amount of magenta.
Cyan Balance	Move the slider to the right to increase the amount of yellow in the cyan. Move the slider to the left to decrease the amount of cyan.
Default	Click the Default button to return all options to their factory settings.

4.5 Image Calibrate

Use the **Image Calibrate** tab to control the position of the printable area in relation to the card.

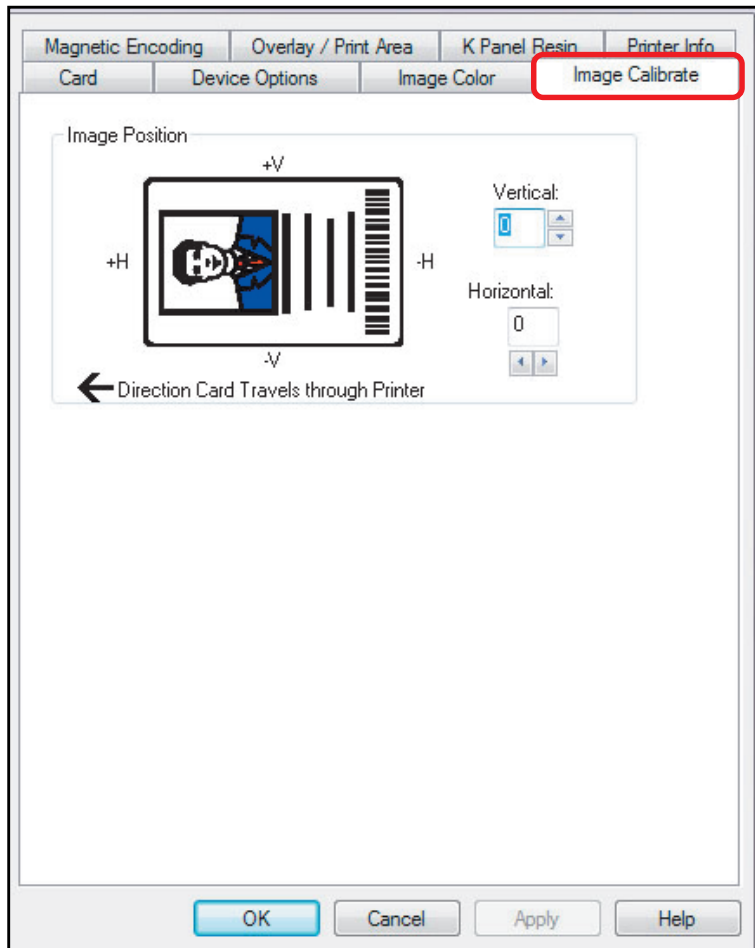

Use the Vertical and Horizontal image position controls to adjust the position of the overall print area to be precisely centered on a card. The maximum value for the Vertical and Horizontal adjustments is ± 100 pixels (10 pixels = approx .03%, .8mm).

Field	Description
Vertical	Use the Vertical adjustment to move the image toward the rear of the printer, if the adjustment is a positive number. Enter a negative number to move the image toward the front of the printer.
Horizontal	Use the Vertical adjustment to move the image toward the rear of the printer, if the adjustment is a positive number. Enter a negative number to move the image toward the front of the printer.

4.6 Magnetic Encoding Tab

Select the **Magnetic Encoding** tab to display options for controlling the Magnetic Stripe encoding process. You can use these options only if the printer has an optional Magnetic Stripe Encoding Module installed.

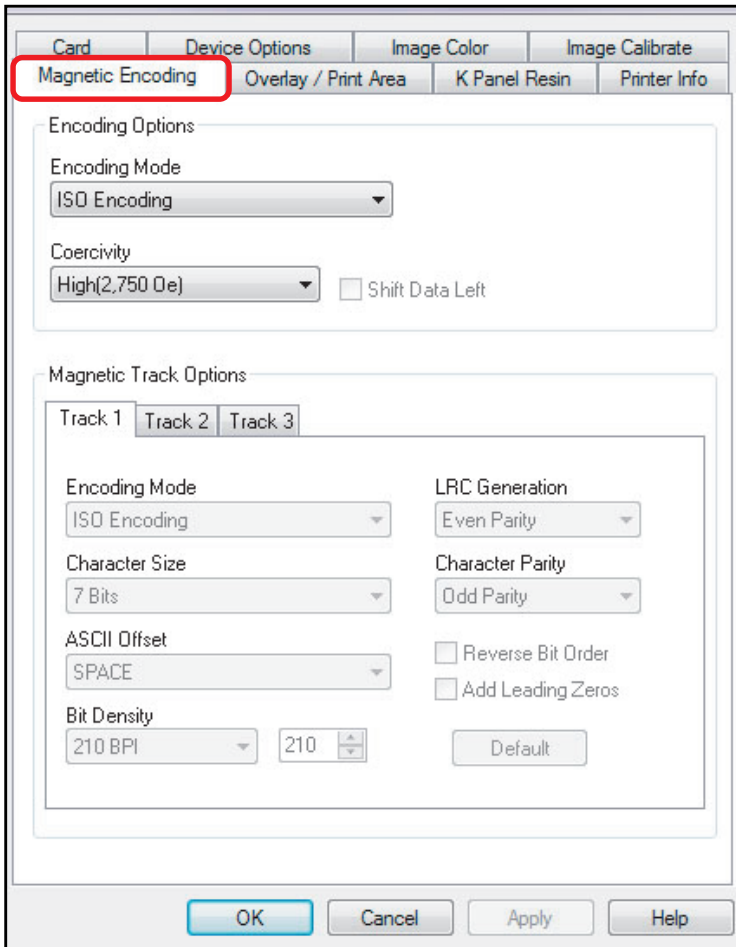

Field	Description
Encoding Options	
Encoding Mode	You can change the encoding mode and coercivity setting or modify the ISO standards for Tracks 1, 2 and 3. This can be done by correctly modifying these Magnetic Encoding options.
ISO Encoding	The ISO Encoding option sends down a formatted set of characters. This selection activates the track tabs. However, all functions on the Track tabs are inactive or gray and display ISO defaults, which are the defaults listed for each track below. The Shift Data Left check box remains unchecked and inactive.

Field	Description
Custom Encoding	<p>If you select Custom Encoding, all options are active. The Default is ISO Encoding.</p> <p>Note: The defaults are the same as the ISO Encoding defaults. All functions on the Magnetic Track Options tabs are active. You can change the Magnetic Track options for Tracks 1, 2 and 3.</p>
Character Size	<p>4 Bits to change the bits per character to 4 BPC. Note: This is the default for Track 3.</p> <p>5 Bits to change the bits per character to 5 BPC. Note: This is the default for Tracks 2 and 3.</p> <p>7 Bits to change the bits per character to 7 BPC. Note: This is the default for Track 1.</p> <p>8 Bits to change the bits per character to 8 BPC.</p>
ASCII Offset	<p>NULL to change the ASCII Offset to NULL.</p> <p>SPACE to change the ASCII Offset to SPACE. Note: This is the default for Track 1.</p> <p>ZERO to change the ASCII Offset to ZERO. Note: This is the default for Tracks 2 and 3.</p>
Bit Density	<p>75 BPI to change the bits per inch to 75 BPI. Note: This is the default for Track 2.</p> <p>128 BPI to change the bits per inch to 128 BPI.</p> <p>210 BPI to change the bits per inch to 210 BPI. Note: This is the default for Tracks 1 and 3.</p> <p>Custom BPI, which enables the custom BPI text box. Note: The lower limit is 75 and upper limit is 210.</p>
LRC Generation	<p>No LRC to change the LRC Generation to none.</p> <p>Even Parity to change the LRC Generation to Even Parity. Note: This is the default for all tracks.</p> <p>Odd Parity to change the LRC Generation to Odd Parity.</p>
Character Parity	<p>No Parity to change the Character Parity to none.</p> <p>Even Parity to change the Character Parity to Even Parity.</p> <p>Odd Parity to change the Character Parity to Odd Parity. Note: This is the default for all tracks.</p>
Reverse Bit Order	<p>Reverse Bit Order is used to reverse the character bits and is used for the encryption of data in specific programs</p>
Add Leading Zeros	<p>Add Leading Zeros is used to add a set number of leading zeros to the magnetic string in order to move the starting point of the encoded data in specific programs for encryption of data.</p>
Raw Binary Encoding	<p>The Raw Binary Encoding option will send down a raw binary string rather than a formatted set of characters.</p> <p>The Coercivity drop-down function is active and the Shift Data Left checkbox is not active.</p> <p>All functions on the Magnetic Track Options tabs are inactive except for Bit Density.</p>
JIS II Encoding	<p>If you select JIS II Encoding, specific standards are used.</p> <p>This selection disables all the Magnetic Track Options tabs. It also disables the Coercivity drop-down function and Shift Data Left checkbox option.</p> <p>The default Coercivity is 600 Oe.</p>

Field	Description
Coercivity	Select the Coercivity option (Oersted) that matches the card type. <ul style="list-style-type: none">• High Coercivity 4000 Oersted• FARGO's High Coercivity UltraCard IIIs are 2750 Oersted• Medium Coercivity=600 Oersted• Low Coercivity = 300 Oersted
Shift Data Left	Select this option to shift the recorded magnetic data to the left-hand side of the card's Magnetic Stripe. This is useful in situations that require cards to be readable with insert type readers.
Magnetic Track Options The magnetic Encoding Module encodes onto tracks in accordance with an ISO 7811-2 Magnetic Stripe. For track locations, review the display below. Tabs are available on the Magnetic Encoding tab with options for encoding data on each track. See <i>Section 4.6.1: Magnetic Track Options</i> for more information.	



4.6.1 Magnetic Track Options

The magnetic Encoding Module encodes onto tracks in accordance with an ISO 7811-2 Magnetic Stripe. For track locations, review the display below. Tabs are available on the Magnetic Encoding tab with options for encoding data on each track.

Reviewing the ISO Track Locations

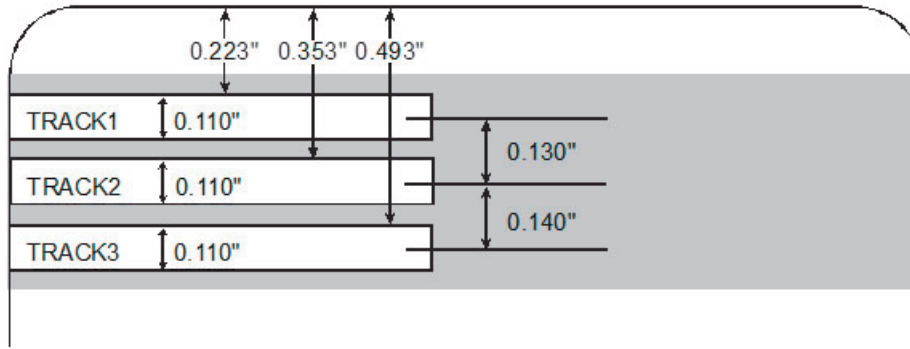

4.6.1.1 Reviewing the Sample String

Track 1: ~1%JULIEANDERSON^1234567890?

Track 2: ~2;1234567890987654321?

Track 3: ~3;1234567890987654321?

Track	Start Sentinel	End Sentinel	Field Separator	Valid Characters	Maximum Number of Characters
Track 1	%	?	^	ASCII 32-95 (see table below)	78
Track 2	;	?	=	ASCII 48-63 (see table below)	39
Track 3	;	?	=	ASCII 48-63 (see table below)	106

4.6.1.2 Sending the Track Data

Magnetic track data is sent in the form of text strings from the application software to the Printer Driver.

In order for the Printer Driver to differentiate between Magnetic Track data and the rest of the printable objects, specific characters must be added to the magnetic data to be encoded.

These specify the data that is to be encoded the tracks to encode and mark the start and stop of the data string. In some cases, these specific characters are automatically added to the string of track data by ID software applications.

In most cases, the user must carefully add these characters to the string of Magnetic Track data. If these characters are not added to the track data, the text intended for the Magnetic Track will appear as printed text on the card. To avoid this, track information must be entered as described below.

When entering track data, the ~ (tilde) character is entered first, followed by the track number (1, 2 or 3) on which the data should encode. The data to be encoded follows the track number.

The first character of this data string must be the track's specific Start Sentinel (SS) and the last character must be the specific End Sentinel (ES).

The characters or data in between the SS and ES can include all of the valid characters specific to each track.

The number of these characters, however, is limited by each track's maximum character capacity.

Note: When segmenting track data, the appropriate Field Separator (FS) must be used. The table below shows the SS, ES, FS and the valid characters defined for each track.

Reviewing the ASCII Code and Character Table

ASCII Code	Character	ASCII Code	Character	ASCII Code	Character
32	space	56	8	80	P
33	!	57	9	81	Q
34		58	:	82	R
35	#	59	;	83	S
36	\$	60	<	84	T
37	%	61	=	85	U
38	and	62	>	86	V
39	'	63	?	87	W
40	(64	@	88	X
41)	65	A	89	Y
42	*	66	B	90	Z
43	+	67	C	91	[
44	'	68	D	92	\
45	-	69	E	93]
46	.	70	F	94	^
47	/	71	G	95	_
48	0	72	H		
49	1	73	I		
50	2	74	J		
51	3	75	K		
52	4	76	L		
53	5	77	M		
54	6	78	N		
55	7	79	O		

4.7 Overlay / Print Area

Use the **Overlay / Print Area** tab to control and customize where the Overlay (O) panel and/or the print area appear on the card. By default, this option is set to print and overlay the entire card.

The orientation of the card display area is determined by the orientation specified in your template.

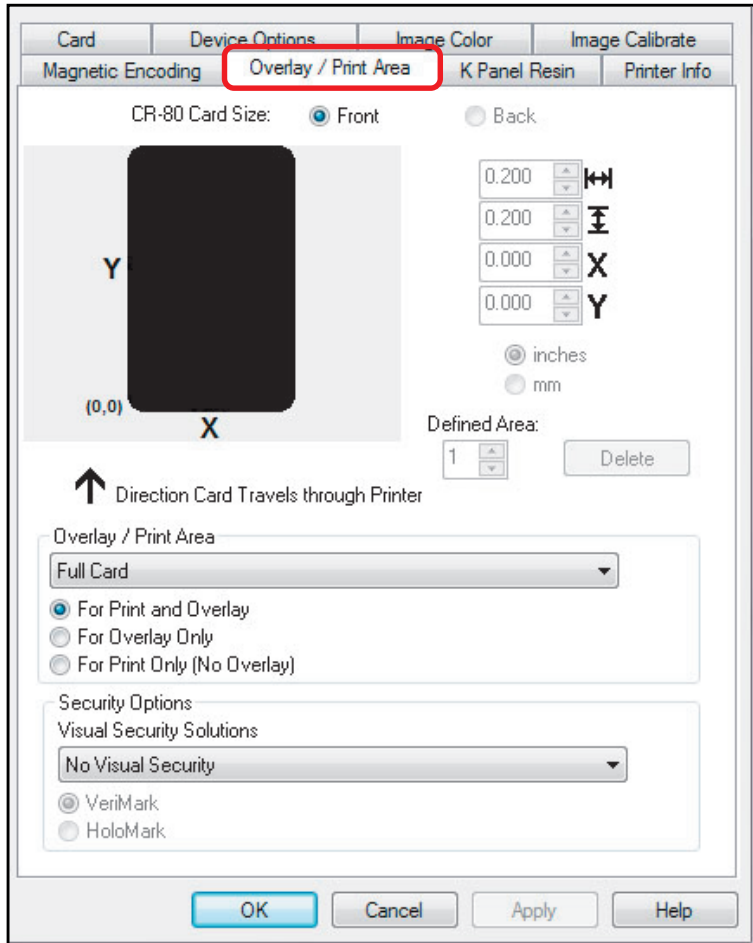

4.7.1 Defining an Overlay or Print Area

To define an overlay or print area:

1. Select the **Front or Back** option to specify the side of the card to apply the area definition.
2. Select **Overlay/Print Area** the drop-down and select the option that serves your purpose.

Field	Description
Overlay/Print Area (pull-down menu)	
Full Card	Select this option to overlay and/or print the entire card.
Defined Area(s)	Select this option to overlay and/or print only in the selected and define an area(s).
Undefined Area(s)	Select this option to overlay and/or print in the space outside the selected and defined area.

Field	Description
Omit Smart Chip Area	Select this option to overlay and/or print only in the space outside the standard location of a smart chip.
Omit Mag Strip Area	Select this option to overlay and/or print only in the space outside the standard location of an ISO-standard magnetic stripe.
Omit Signature Area	Select this option to overlay and/or print only in the space outside the standard location of a signature panel.

3. When an option is selected, a default blacked area appears on the card design area grid.

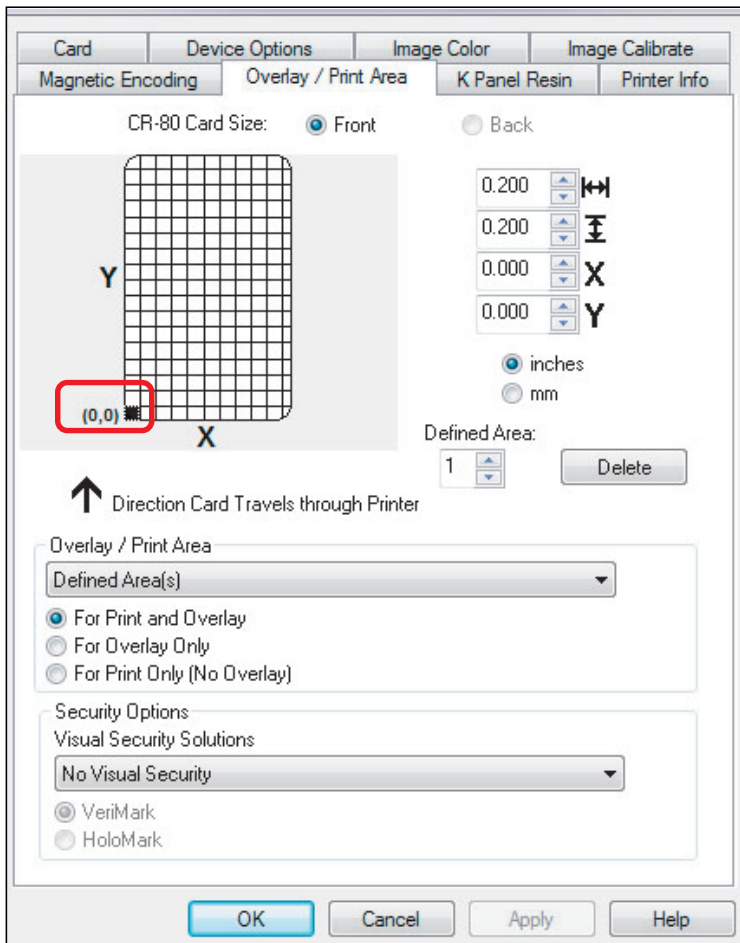

4. Select and drag to enlarge the area and move it to the preferred location on the card. The size and coordinates of the area will update the number fields (inches or mm).

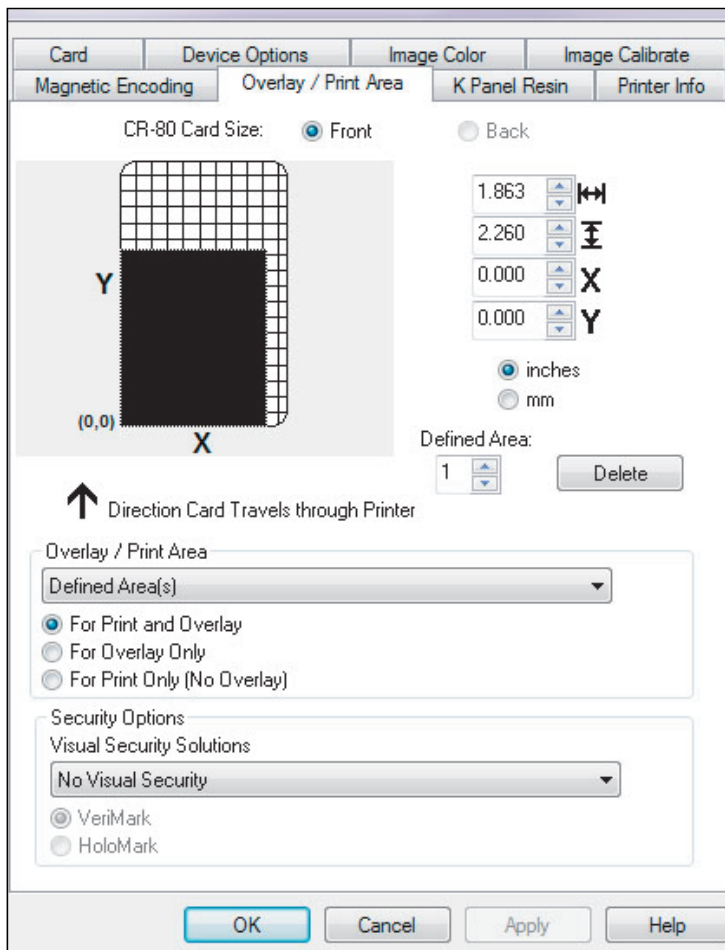

Field	Description
Overlay/Print Area	
Full Card	Select this option to overlay and/or print the entire card.
Defined Area(s)	Select this option to overlay and/or print only in the selected and define an area(s).
Undefined Area(s)	Select this option to overlay and/or print in the space outside the selected and defined area.
Omit Smart Chip Area	Select this option to overlay and/or print only in the space outside the standard location of a smart chip.
Omit Mag Strip Area	Select this option to overlay and/or print only in the space outside the standard location of an ISO-standard magnetic stripe.
Omit Signature Area	Select this option to overlay and/or print only in the space outside the standard location of a signature panel.
For Print and Overlay	This option applies the defined area to both the print and overlay processes.

Field	Description
For Overlay Only	The defined are applies only to the overlay process. The entire card prints and only the overlay is affected.
or Print Only (No Overlay)	The defined are applies only to the print process. Overlay is disabled.
Security Options	
Visual Security Solutions	<p>Use this field to enable and select a visual security option. When one of the options is selected, the Overlay/Print Area feature is disabled.</p> <p>This field presents options based on the orientation of the card in the template. The default value for all cards is No Visual Security.</p> <p>Landscape designs offer:</p> <ul style="list-style-type: none"> A - Upper Left B - Upper Right C - Lower Left D - Lower Right <p>Portrait designs offer:</p> <ul style="list-style-type: none"> E - Upper Left F - Upper Right G - Lower Left
HoloMark	Use this option for hologram security.

4.8 K Panel Resin Tab

Use the **K Panel Resin** tab to control where the resin black (K) Panel of a full-color ribbon is printed. If a ribbon without a K resin panel is installed in your printer, these options are grayed out and unavailable.

Note: Orientation of the card display area is determined by the orientation specified in the template. See *Section 4.7.1: Defining an Overlay or Print Area* for information on the card size, etc.

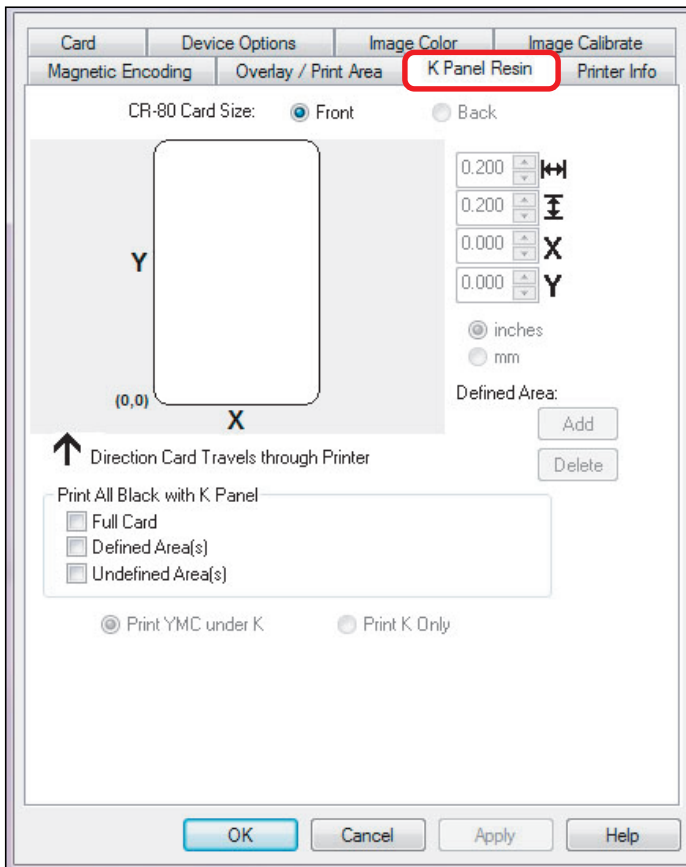

Field	Description
Print All Black with K Panel	
Full Card	Select this option to overlay and/or print the entire card.
Defined Area(s)	Select this option to overlay and/or print only in the selected and define area(s). See <i>Section 4.8.1: Defined Area</i> .
Undefined Area(s)	Select this option to overlay and/or print in the space outside the selected and defined area.
Print YMC under K	Select this option to print all black in the designated areas with the yellow (Y), magenta (M) and cyan (C) ribbon panels directly beneath the resin black (K) panel. This combination provides a gradual transition between the resin black text or bar code.
Print K Only	Select this option to print using the resin black (K) panel onto a white background to maximize the sharpness of printed text and bar codes.

4.8.1 Defined Area

The Defined Area option can be used with the K Panel Resin or the Overlay / Print Area tabs to define one or more specific areas.

In the samples, the defined area is indicated by the dashed outline.

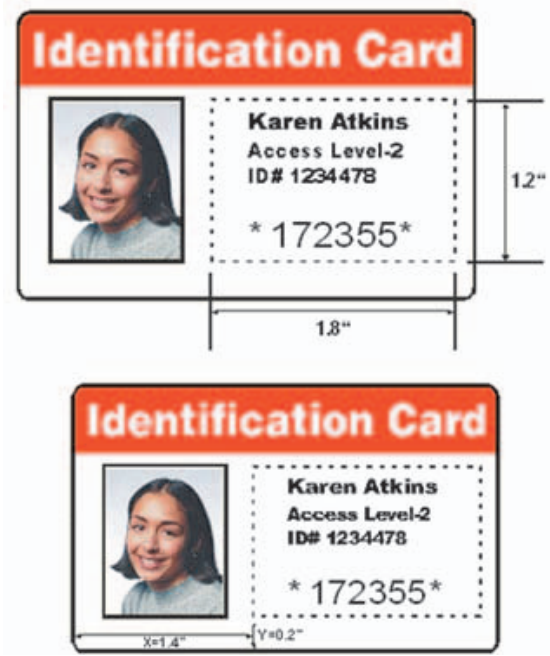

4.8.1.1 Method for Defining a Single Area

1. On the **Overlay / Print Area** or **K Panel Resin** tab, select **Defined Area(s)**.
2. Print a card and look at it in the same orientation as when it exits the printer.
3. Measure the total size of the area and enter the dimensions into the dimension boxes.
4. Measure from the lower-left corner of the card to the lower-left corner of the defined area and enter the values into the X and Y boxes.

4.8.1.2 Method for Defining Multiple Areas

1. On the **Overlay / Print Area** or **K Panel Resin** tab, select **Defined Area(s)**.
2. Print a card with a defined area and look at it in the same orientation as when it exits the printer.
3. Measure the defined area location based on the printed card.
4. To define another area, click the **Defined Area** up-arrow.
5. Use the Defined Area arrows to navigate back and forth from area to area.

4.9 Printer Info

Use the options on this tab to view information about the medias installed on the printer:

- Ribbon
- Card Count
- Printer Serial #
- Firmware Version
- Reorder Number

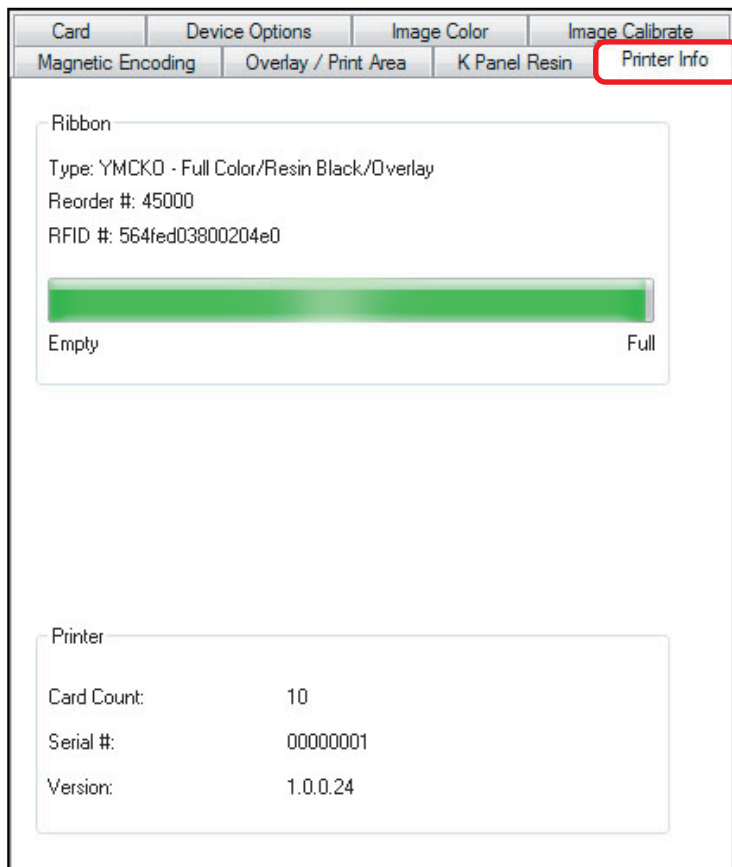



System Overview - Troubleshooting

5.1 Sequence of Operations

Knowing the sequence of the printer operation helps when troubleshooting the printer.

1. File information is received from the PC.
2. Printer compares the installed ribbon type stored in memory with the ribbon type command that was sent from the printer. If the ribbon type does not match, the Pause button (on the right) flashes.
3. The print stepper motor engages.
4. The card feed sensor detects the leading edge of the card and the headlift stepper engages to disengage the input lever.
5. The card feeds through for the alignment pass.
6. The card feed stepper motor engages to queue card for magnetic encoding (if applicable).
7. The encoded data is written to the card (if applicable).
8. The magnetic encoder verifies while the stepper reverses the card (if applicable).
9. The print ribbon drive engages (if not already at the yellow panel).
10. The print ribbon sensor looks for the yellow panel.

Note: The print ribbon encoder detects the number of revolutions required to use an entire color panel.

11. The print stepper motor engages.
12. The card feed sensor detects the leading edge of card.
13. The print stepper motor queues card to the middle of the platen roller. All stop.
14. The print headlift motor engages to the print position.
15. The print cover sensor checks for closed state.
16. The print stepper motor engages.
17. The ribbon drive motor engages.
18. The image data is burned by the printhead until the image data is depleted. All Stop.
19. The thermistor engages the printhead cooling fan to maintain proper operating temperature.
20. The headlift motor engages to the queue position.
21. The print stepper motor engages.
22. The print ribbon drive engages.
23. After ribbon advances a few encoder clicks, assume the ribbon is free of card. All stop.

- 24.Repeat Steps 9 through 22 for the appropriate number of color/overlay Panels.
- 25.Either the card is ejected from the singled-sided printer or the card feed stepper engages to queue the card for the flipper table for the dual-sided printer.
- 26.All stop.

5.2 Troubleshooting





5.2.1 Printer Error Buttons

The DTC1250e and DTC4250e use button messages rather than a display message system. All Printers have two (2) buttons.



The display message system appears as a graphical message, for example:





1. The **ON/OFF**  button is blue when the printer is **ON**. When the printer enters the Sleep mode, the button LED is dimmed but still ON.
2. The **Pause**  button illuminates blue when the printer is capable of accepting a print job and is not in an error state.
This button LED will continue to stay on while the printer prints as long as there is no error.
This button LED will also be dimmed when the printer goes into Sleep mode.
3. When an error occurs, the **Pause**  button no longer illuminates blue but blinks red.
4. Press the **ON/OFF**  button when printer is in an error state to cause the action to be canceled.

Note: If no other error occurs, the Pause button illuminates as blue.

5. Press the **Pause**  button when printer is in an error state to cause the printer to retry.

Note: The button illuminates as blue and retries the failed action.

6. When downloading an upgrade file, both buttons are blue and blink. If the unit is a DTC1250E, you are notified that the upgrade is in process.
7. If a language (other than English) is currently selected, you can press and hold the **Pause**  button during the power-up sequence to change the language back to English.
8. When no printer display is available, press or hold the buttons to access some internal tests.
 - To print a card with the Printer Settings, press the **Pause**  button and hold for 4+ seconds when the printer is ready and idle.
 - To print the Alignment or the Self Test, press and hold the **Pause**  button during the power-up sequence.

5.2.2 Error Messages

This section provides the troubleshooting table for the error message. The DTC4250E has a display that shows the printer error messages.

- When an error occurs in the printer, the PC shows the error message on screen with solutions.
- The display blinks in the location requiring attention. Locations can include the printer, input hopper, magnetic encoder, flipper, card path, ribbon, and data/communication device error.

Each table uses a 3-column presentation to display a specific or printer error message, its cause and its solution.

- This format allows the troubleshooter to identify the error and its cause, and then perform the procedure provided in the solution column.
- This standard mode of identifying the problem and its solution should provide an efficient method of troubleshooting this printer.
- If you encounter problems beyond the capabilities of this error message table, you should contact Technical Support.

Error Message	Cause	Solution
# 81 Unable to Feed	The printer is unable to feed a card from the input card hopper.	Check the following, then press the Pause [] button to continue. <ul style="list-style-type: none"> • Verify the card thickness setting is set to the thickness of your cards. • Verify the Cleaning roller is properly installed on the Ribbon Cartridge. • Check for card slippage. If necessary, run the Printer cleaning routine. • Verify that your cards are within the accepted card size range. • Verify the cards are not sticking together.



5.2.3 Troubleshooting with the Error Message Table

Error Message	Cause	Solution
# 2 Head Move Error	The printhead lift has malfunctioned.	Reset the printer and try again. If this problem persists, call for technical assistance.
# 8 Head Sensor Error	The printhead temperature sensor is not functioning or is not connected properly. Or, the printhead is not cooling properly.	Reset the printer and try again. If the problem persists, call for technical assistance.
# 9 Reboot Required	An unspecified system error has been detected by the printer firmware.	Reset the printer and try again. If this problem persists, call for technical assistance.
# 25 Ribbon not Installed	No ribbon is installed in the printer.	Install a ribbon and retry.
# 30 Mag Verify Error	Magnetic encoding verification has failed.	Try encoding with a different card. Verify cards have the magnetic stripe. Replace the magnetic encoding module.
# 31 No Mag Module	The printer is not configured with the encoder data type that you are trying to send.	Ensure that no encoding data is being sent with the print job and reprint the card. Install a magnetic encoding module.
# 38 # 39 # 40 EEPROM Corrupt EEPROM Read Error	EEPROM is restored with factory default values.	If changes were made in the Advanced Settings tab in the printer driver, click the Default button to reset these numbers. Reset the printer and try again. If this problem persists, call for technical assistance.

Error Message	Cause	Solution
# 44 Flipper Jam/ Home Error	A card has become jammed in the printer's flipper table. The flipper failed to position properly while aligning a card or flipping a card.	Clear any cards in the flipper table using the buttons to move the card out. Resume printing. The flipper table should be level when the printer is powered up. If the flipper Table is at an angle, open the card output door and manually level it. Then cycle the printer power to reset. Reset the printer and retry. If problem persists call for technical assistance.
# 45 No Flip Module installed	Request to print on 2 nd side of card, but no flipper is installed.	If a Flipper Module is present, ensure that the Print Both Sides option in the printer driver is set correctly. Install a flipper module.
# 64 # 65 # 66 Reboot Required	Unspecified system error detected by the printer firmware.	Reset the printer and try again. If this problem persists, call for technical assistance.
# 68 Card in Printer	A card is jammed in the print station or card flipping area of the Printer.	Clear the jam and press the Pause [] button.
# 70 Multiple Feed	Multiple cards were fed into the printer.	Verify the card thickness is set to the thickness of your cards, then press the Pause [] button. Check for card slippage. If necessary, run the printer cleaning routine. Verify the cleaning roller is properly installed on the ribbon cartridge. Verify the cards are not sticking together.
# 81 Unable to Feed	The printer is unable to feed a card from the input card hopper.	Check the following, then press the Pause [] button to continue. Verify the card thickness setting is set to the thickness of your cards. Verify the Cleaning roller is properly installed on the Ribbon Cartridge. Check for card slippage. If necessary, run the Printer cleaning routine. Verify that your cards are within the perimeters accepted card size range. Verify the cards are not sticking together.
# 82 Mag Jam	A card is jammed magnetic station	Clear any cards in the magnetic station using the buttons to move the card out. Press the Pause button to continue.
# 91 Ribbon Out	The print ribbon has run out.	Install a new ribbon. Press the Pause [] button to continue or the ON/OFF button to cancel.

Error Message	Cause	Solution
# 93 Wrong Ribbon	The print ribbon installed in the printer does not match the ribbon type selected in the printer driver.	Change either the installed print ribbon or the ribbon type selected in the printer driver. Press the Pause [] button to continue or the ON/OFF button to cancel.
# 97 Ribbon Search Error	The ribbon is not able to find the next panel correctly. Check for jams/breaks.	Recalibrate the ribbon sensor. If broken, repair by taping the ribbon back on to the take-up core. Replace the ribbon. Press the Pause [] button to continue or the ON/OFF button to cancel.
# 99 Ribbon Error	The print ribbon has either broken or jammed.	If jammed, clear the jam. If broken, repair by taping the ribbon back on to the take-up core. Press the Pause [] button to continue or the ON/OFF button to cancel.
# 100 Ribbon RFID Error	There is no ribbon or the ribbon tag information is corrupted or incorrect.	Verify the printer driver settings for correct Ribbon. Try a new ribbon and continue. Press the ON/OFF button to cancel.
# 102 # 103 # 104 #3 Headlift Error	This is a problem with the printhead Lift.	Reset the printer and try again. If this problem persists, call for technical assistance.
# 106 Job Data Error	The print data sent to the printer is corrupt or has been interrupted.	Check the interface cable. Select the ON/OFF button to cancel this print job and then resend the job.
# 107 Printing Error	An error was detected during printing.	Reset the printer and try again. If this problem persists, call for technical assistance.
# 109 # 113 Ribbon Release Error	The printer cannot locate the next ribbon panel in order to release the ribbon from the card.	Ensure that the ribbon is not stuck to the card. Replace the ribbon. Recalibrate the ribbon sensor. If the ribbon is broken, repair by taping the ribbon back onto the take-up core and manually advance to the next panel. Press the Pause [] button to continue.

Error Message	Cause	Solution
# 110 Card Jam/Align error	A card is jammed in the print station or card flipping area of the printer.	Clear the jam. Press the Pause [] button to continue.
# 111 Head Loading	An unrecoverable error has occurred during printing.	Reset the printer and try again. If this problem persists, call for technical assistance.
# 112 Card Jam/Align error	A card is jammed in the print station or card flipping area of the Printer.	Clear the jam. Press the Pause [] button to continue.
# 128 # 170 Calibrate Ribbon	The print ribbon sensor is out of calibration or has failed.	Calibrate the ribbon sensor. Check for material blocking sensor and try again.
# 131 Flipper Jam/Home Error	A card has become jammed in the printer's flipper table. The flipper failed to position properly while aligning a card or flipping a card.	Clear any cards in the flipper table, using the buttons to move the card out. Resume printing. Reset the printer and retry. If problem persists call for technical assistance.
# 136 Secure Guard Print Disabled	Printing is disabled by SecureGuard until a password is received.	Reset the printer and retry. If the problem persists, call for technical assistance.
# 139 Please Remove Ribbon	Ribbon needs to be removed.	Reset the printer and retry. If problem persists, call for technical assistance.

Error Message	Cause	Solution
# 144 EEPROM Corrupt EEPROM Read Error	EEPROM restored with factory default values.	If changes were made in the Advanced Setting tab in the printer driver, click the Default button to reset these numbers. Reset the printer and try again. If this problem persists, call for technical assistance.
#202 Encoder not installed	You are trying to send encoding data, but the Printer is not configured with this Encoder type. iCLASS, Prox, MIFARE, SmartCard	Ensure that no encoding data is being sent with the print job and reprint the card. Install an encoding module.

5.2.4 Printer-Specific Tools (DTC1250E, DTC4250E)



The status icons are as follows:

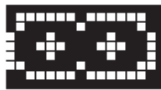

This icon indicates that the print ribbon supply is low and will require replacement soon. For the DTC1250E and DTC4250E models, the entire ribbon cartridge must be replaced.









This icon indicates that the printer needs to be cleaned.



This icon is only displayed for printers with an attached dual-input card hopper and indicates that the top input hopper is currently selected.



This icon is only displayed for printers with an attached dual-input card hopper and indicates that the bottom input hopper is currently selected.

- Press the  button to scroll through the details of the printer and perform the action.
- Press the  button to select the option.
- When  is selected, use the left down arrow  to scroll through the Info, Test Prints, and Languages and Exit.
- Use the corner arrow  to run that option.
- The curved arrow  will return to the first screen.

5.2.4.1 Additional Printer Specific Tools

Label	Description
INFO	<ul style="list-style-type: none"> • Printer Type • Firmware Version • IP Address • Flipper • Lamination • Magnetics • E-Card • Password • Card count
TEST PRINTS	<p>Color Photo: Select this to print a color card to test communication and integrity.</p> <p>Alignment: Select this to print a card used to align the print image on the card.</p> <p>Settings: Select this to print a card with the Advanced settings.</p> <p>Resin: Select this to print a RESIN test card.</p> <p>Rewritable: Select this to ERASE the Rewritable card.</p> <p>Magnetic: Select this to test Magnetic encoding. (Hi-Co only)</p> <p>Lamination: Select this to laminate a test card.</p>
Hopper Select	Ability to select which hopper to feed cards from. Applies to Dual Hopper Printers.
Toolbox	<p>Clean Printer: Select this to run the clean printer routine.</p> <p>Clean Laminator: Select this to run the clean laminator routine.</p> <p>Calibrate Mag: Select this to calibrate the Magnetic Sensor</p> <p>Calibrate Rib Sensor: Select this to calibrate the ribbon sensor.</p> <p>Network: Select this to configure network options.</p>
Language	Select this choice to change the Printer Displayed Language.
Exit	Select this choice to exit the Printer Tool options.

This page intentionally left blank.

Firmware Upgrades

6.1 Upgrade Information

To upgrade the printer's firmware, perform the following steps:

1. Run the **FARGO Workbench Printer Utility**.
2. If running FARGO Workbench Version 3 or greater:
 - a. Select the **Update Manager Workbench Utility**.
 - b. Select the printer(s) to update.
 - c. Click **Select Firmware file...** option to locate or enter this latest firmware file (FRW-00373_DTC100_v2.3.3.20.frm).
 - d. Browse for the firmware file or enter the firmware file name and click **Open**.
 - e. Click **Begin Updating Firmware** to send the file to the printer(s).
3. If running a FARGO Workbench release prior to Version 3:
 - a. Select the **Application Menu** at the upper left, and select **Upgrade Firmware**.
 - b. Enter the firmware file name or click **Browse** to find and select this latest firmware file (FRW-00373_DTC100_v2.3.3.20.frm).
 - c. Click **OK** to send the file to the printer(s).
4. Restart the printer if it does not restart automatically.

This page intentionally left blank.



Chapter 7

Technical Support

This section provides you with an efficient, step-by-step procedure to be used when contacting HID GLOBAL Technical Support, as needed, for this card printer.

Contact the HID Global Technical Support Group:

Phone: (866) 607-7339 Ext #6

FAX: (952) 946-8492

Website: support.hidglobal.com

Before contacting HID Technical Support:

- Position a phone near the printer and computer so the Technician can help to troubleshoot the printer.
- Have a self-test and a sample card ready when calling HID Technical Support.

7.1 Reading the Serial Numbers on a FARGO Printer

To determine when the card Printer was manufactured, see the serial number (affixed to the card printer).

With the Example: **Serial Number B2050028 (2012)**

- The first two digits in the serial number indicate the year the printer was built (B2 indicates the year 2012).
- The third and fourth digits in the serial number indicate the week the printer was built (05 indicates week 5 of that year).
- The last four digits indicate the sequence number for the numeric order in which the printers were built.

This page intentionally left blank.



Appendix A

DTCii

This section is specific to the DTCii printer only.

Dimensions:

10.05~H x 22.94~W x 10.27~D/255.3mmH x 582.7mmW x 260.9mmD

A.1 Locking System

The DTCii provides additional security with the inclusion of locks on the following components:

- Card Input
- Reject Hopper
- Material Door

A set of two identical keys are provided that will unlock all sections of the printer. In the event that these keys are misplaced, please contact HID Customer Services.

A.2 Accessory Procedures: Using the Security Lock Slot

IMPORTANT: Compatible locks are not sold by HID Global; however, they are readily available from computer stores.

The DTCii printer has a Security Lock Slot located in the back lip of the metal chassis to accommodate a standard laptop security lock.

To prevent unauthorized removal of the DTCii, attach an industry standard security cable to an immovable object and then lock the cable to the Security Lock Slot.

Note: HID Global does not sell any type of locking device, but provides this feature for your added security.

The lock slot has a plastic covering that needs to be penetrated by the lock.

Note: Push the lock end into the slot with adequate force to break the protective film.

Follow the locking procedure recommended by the lock vendor.

This page intentionally left blank.

Revision History

Date	Description	Version
December 2016	Updates to include DTCii model information.	1.2
March 2014	Updates to print ribbon options, speeds and counts. Updated liability statement to new copyright statement. Updated safety instructions to include French, correct symbology. Removed Swift ID information.	1.1
October 2013	First Release	1.0

